



Accessories Catalog



Product Quality, Reliability and Support You Expect

www.catpumps.com

Demand Genuine Cat Pumps® Accessories

Maximum High-Pressure System Performance

Cat Pumps offers a wide range of high quality accessories adhering to the same exacting standards as our industry-leading pumps. Every accessory is performance tested and designed to match each pump's operating specifications. By demanding genuine Cat Pumps products, you receive the best value and lowest cost of ownership over the life of the system.

For maximum system protection, Cat Pumps recommends the use of a primary regulating device, secondary pressure relief device, and discharge pressure gauge. In addition to these system components, this catalog includes hundreds of other genuine Cat Pumps accessories. Improve system performance and protect your pumping system investment with the brand you can trust — Cat Pumps.

Table of Contents

Typical Installation	3	Vari-Nozzles	19
Discharge Accessories	4	Foamers	19
CPC Pressure Regulators	4	Chemical Injectors	20
Unloaders, Trapped Pressure	5	Pulse Pumps	20
Pressure Relief Valves	6	Lubrication Accessories	21
Pop-Off Valves	7	Crankcase Oil	21
Pressure Gauges	8	Gear Lube	21
Valve Plug Adapters	8	Anti-seize and Sealants	22
Quick Disconnect Assemblies	8	Pump Protector	22
Pulsation Dampeners	9	Pump Accessories	23
Inlet Accessories	10	Oil Drain/Level Indicator Kits	23
Filters	10	Protectors – Shaft and Oil Cap	23
Inlet Pressure Gauges	10	Keys	24
Inlet Pressure Regulators	11	Rails	25
Inlet Stabilizers	11	Drive Accessories	25
Thermal Valves	12	Bell Housing and Flexible Couplings	25
Garden Hose Assemblies	12	Direct-Drive Mounting Components	26
Specialty Accessories	13	Hubs and Hub/Key Assemblies	27
Quick-Start Valves	13	Clutches	28
Throttle Control	13	Pulleys and Pulley/Hub w/Key	28
MAG-JET and Pulsator Assemblies	13	Service Tools	29
Flow Switches	13	Wrenches	29
Auto-Shutoff Assemblies	14	Pliers	29
LPS Monitors	14	Oil Gauge Removal Tool	29
Float Valves	14	Seal Case Removal Tools	30
Pressure Switches	15	Piston Pump Tools	30
Operator Controls	16	Crankcase Oil Seal kit	30
Guns and Lance Assemblies	16	Demand Genuine Cat Pump Accessories	31
Lances	17		
Nozzles	18		

Typical Installation

- 1 Unloader
- 2 Regulator
- 3 Pop-Off Valve
- 4 Relief Valve
- 5 Pressure Gauge
- 6 Pulsation Dampener*
- 7 Inlet Filter
- 8 Inlet Pressure Regulator
- 9 Inlet Stabilizer
- 10 Thermal Valve
- 11 Oil Gauge/Drain Kit
- 12 Quick-Start Valve

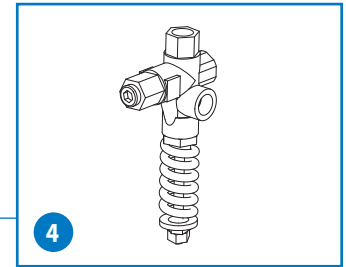
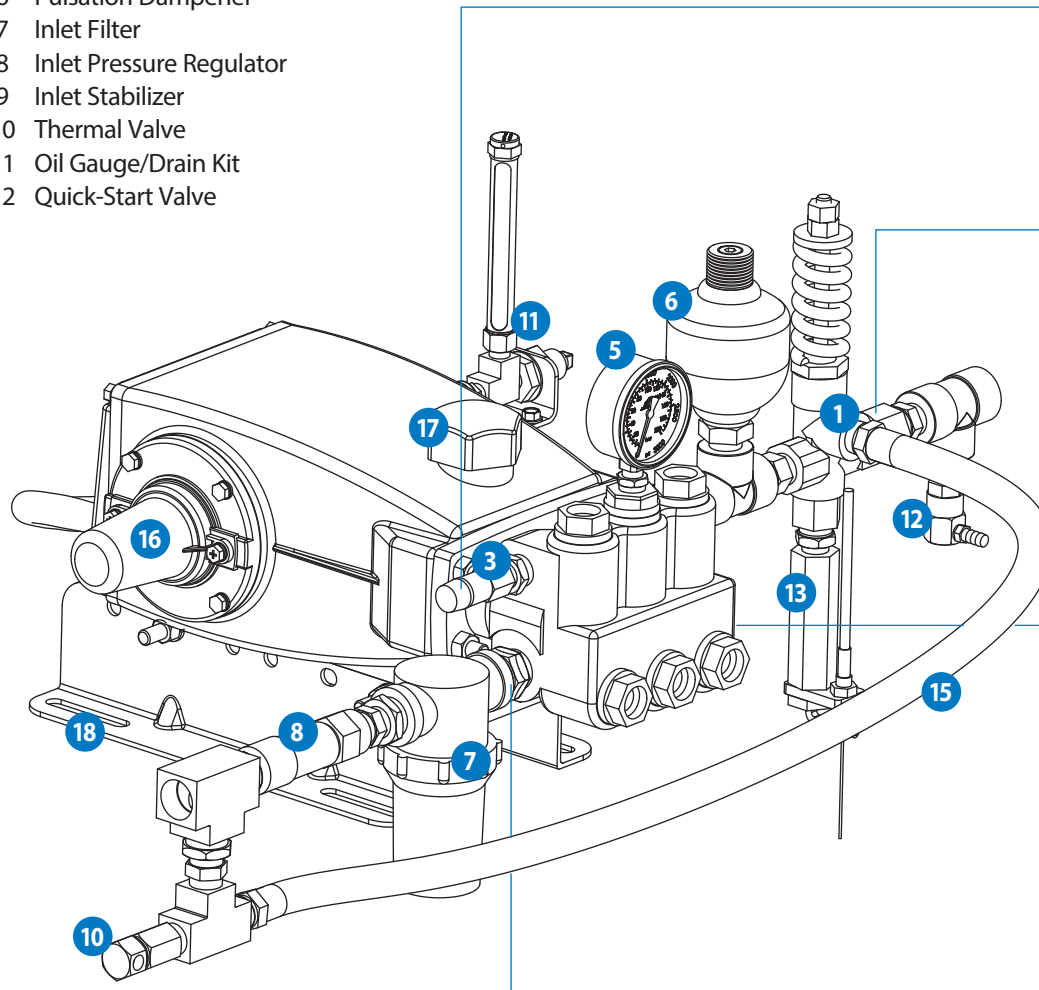

Relief Valve

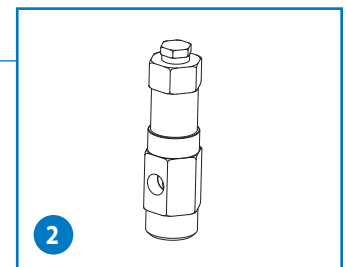

Regulator

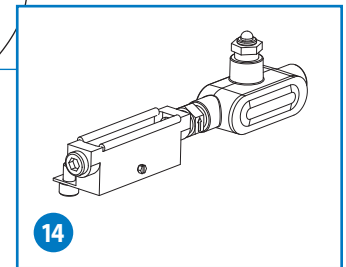

LPS Monitor

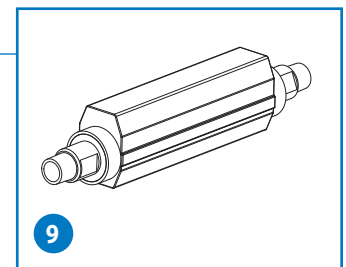

Inlet Stabilizer

- 13 Throttle Controller
- 14 LPS Monitor
- 15 Bypass Hose
- 16 Shaft Protector
- 17 Oil Cap Protector
- 18 Rails

NOTE: These illustrations show the basic elements for a typical installation of a high-pressure piston or plunger pump. **Not all components shown are required for all applications or systems.** Proper system installation, routine lubrication, monitoring and maintenance of components are basic guarantees of optimum pump performance. Cat Pumps does not assume any liability or responsibility for the design or operation of a customer's high-pressure system.

*Preferred mounting of the pulsation dampener is directly on the discharge manifold of the pump. Systems using a pressure unloader require the pulsation dampener installed down stream when the bypass is returned to the inlet of the pump and an inlet pressure regulator or check valve is used.

Discharge Accessories



Primary Pressure Control

CPC Pressure Regulators

- Cat Pumps manufactured product.
- Typically used for multiple pump, nozzle and gun applications.
- Conical design lowers minimum required bypass flow and eliminates cavitation effects, extending performance life.

MODEL	FLOW RANGE		PRESSURE RANGE		PORTS	
	gpm	lpm	psi	bar	Inlet/Discharge	Bypass
STEEL NICKEL PLATED MODELS, FLOW THROUGH (Piston and Seat are 316 Stainless Steel)						
7001	0.5 - 5	1.9 - 19	100 - 1000	6.9 - 69	3/8" NPT(F)	1/2" NPT(F)
7002	0.5 - 5	1.9 - 19	500 - 2000	35 - 138	3/8" NPT(F)	1/2" NPT(F)
7003	0.5 - 5	1.9 - 19	1500 - 3000	103 - 207	3/8" NPT(F)	1/2" NPT(F)
7011	1.0 - 10	3.8 - 38	100 - 1000	6.9 - 69	1/2" NPT(F)	3/4" NPT(F)
7012	1.0 - 10	3.8 - 38	500 - 2000	35 - 138	1/2" NPT(F)	3/4" NPT(F)
7013	1.0 - 10	3.8 - 38	1500 - 3000	103 - 207	1/2" NPT(F)	3/4" NPT(F)
7014	1.0 - 10	3.8 - 38	2000 - 4000	138 - 275	1/2" NPT(F)	3/4" NPT(F)
7021	2.5 - 25	9.5 - 95	100 - 1000	6.9 - 69	3/4" NPT(F)	1" NPT(F)
7022	2.5 - 25	9.5 - 95	500 - 2000	35 - 138	3/4" NPT(F)	1" NPT(F)
7023	2.5 - 25	9.5 - 95	1500 - 3000	103 - 207	3/4" NPT(F)	1" NPT(F)
7024	2.5 - 25	9.5 - 95	2000 - 4000	136 - 275	3/4" NPT(F)	1" NPT(F)
7031	3.5 - 35	13.2 - 132	250 - 1000	18 - 69	3/4" NPT(F)	1" NPT(F)
7032	3.5 - 35	13.2 - 132	1000 - 2000	69 - 138	3/4" NPT(F)	1" NPT(F)
7033	3.5 - 35	13.2 - 132	1500 - 3000	103 - 207	3/4" NPT(F)	1" NPT(F)

TECH TIP

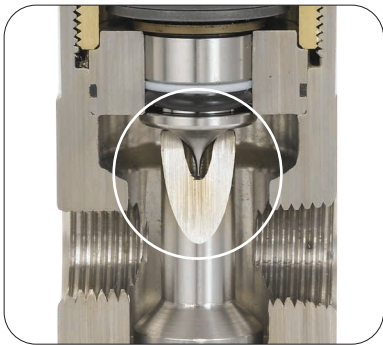

7001-7033, 7375, 7376 Series Regulators exclusively from Cat Pumps feature conical design delivering unmatched performance and life.

Features:

- Conical design lowers minimum bypass flow from 10% - 5%, optimizing system performance
- Virtually eliminates cavitation effects across piston and seat, significantly extending life
- Compact in-line plumbing
- Low-pressure override provides smooth and stable operation without chatter.

316 STAINLESS STEEL MODELS, FLOW THROUGH

(Piston and Seat are 316 Stainless Steel)

7001.100	0.5 - 5	1.9 - 19	100 - 1000	6.9 - 69	3/8" NPT(F)	1/2" NPT(F)
7002.100	0.5 - 5	1.9 - 19	500 - 2000	35 - 138	3/8" NPT(F)	1/2" NPT(F)
7003.100	0.5 - 5	1.9 - 19	1500 - 3000	103 - 207	3/8" NPT(F)	1/2" NPT(F)
7011.100	1.0 - 10	3.8 - 38	100 - 1000	6.9 - 69	1/2" NPT(F)	3/4" NPT(F)
7012.100	1.0 - 10	3.8 - 38	500 - 2000	35 - 138	1/2" NPT(F)	3/4" NPT(F)
7013.100	1.0 - 10	3.8 - 38	1500 - 3000	105 - 207	1/2" NPT(F)	3/4" NPT(F)
7014.100	1.0 - 10	3.8 - 38	2000 - 4000	138 - 275	1/2" NPT(F)	3/4" NPT(F)
7720	0.5 - 10	1.9 - 38	2000 - 10000	138 - 689	1/4" NPT(F)	3/8" NPT(F)
7021.100	2.5 - 25	9.5 - 95	100 - 1000	6.9 - 69	3/4" NPT(F)	1" NPT(F)
7022.100	2.5 - 25	9.5 - 95	500 - 2000	35 - 138	3/4" NPT(F)	1" NPT(F)
7023.100	2.5 - 25	9.5 - 95	1500 - 3000	103 - 207	3/4" NPT(F)	1" NPT(F)
7024.100	2.5 - 25	9.5 - 95	2000 - 4000	138 - 275	3/4" NPT(F)	1" NPT(F)
7031.100	3.5 - 35	13.2 - 132	250 - 1000	18 - 69	3/4" NPT(F)	1" NPT(F)
7032.100	3.5 - 35	13.2 - 132	1000 - 2000	69 - 138	3/4" NPT(F)	1" NPT(F)
7033.100	3.5 - 35	13.2 - 132	1500 - 3000	103 - 207	3/4" NPT(F)	1" NPT(F)
7375	10 - 75	38 - 284	100 - 1000	6.9 - 69	1-1/4" NPT(F)	1-1/2" NPT(F)
7376	10 - 75	38 - 284	500 - 2000	35 - 138	1-1/4" NPT(F)	1-1/2" NPT(F)
7410	10 - 100	38 - 378	100 - 1500	6.9 - 103	1-1/2" NPT(F)	2" NPT(F)

316 STAINLESS STEEL MODELS, TEE MOUNT

7350	1.0 - 12	3.8 - 45	400 - 1500	25 - 103	1/4" NPT(F)	3/8" NPT(F)
7366	1.0 - 12	3.8 - 45	3000 - 6000	207 - 414	1/2" NPT(F)	3/4" NPT(F)
7361	10 - 60	38 - 228	400 - 1000	25 - 69	1" NPT(F)	1-1/4" NPT(F)
7363	10 - 60	38 - 228	600 - 1800	40 - 125	1" NPT(F)	1-1/4" NPT(F)

Primary Pressure Control

Unloaders, Trapped Pressure

- Typically used with trigger gun applications.
- Reduces load on pump and motor when in bypass.
- Easy converted into a relief valve.

MODEL	FLOW RANGE		PRESSURE RANGE		PORTS	
	gpm	lpm	psi	bar	Inlet/Discharge	Bypass
BRASS MODELS						
7500S	0.5 - 6.0	1.9 - 23	100 - 2000	6.9 - 138	3/8" NPT(M)	3/8" NPT(F)
7581	0.5 - 6.5	1.9 - 25	230 - 2300	16 - 158	3/8" NPT(M)	3/8" NPT(F)
7582	0.5 - 8.0	1.9 - 30	100 - 1000	6.9 - 69	3/8" NPT(M)	3/8" NPT(F)
7583	0.5 - 8.0	1.9 - 30	250 - 2000	18 - 138	3/8" NPT(M)	3/8" NPT(F)
7620	0.5 - 8.0	1.9 - 30	100 - 3200	6.9 - 220	3/8" BSP(M)/BSP(F)	3/8" BSP(F)
7693	2.5 - 10.5	9.5 - 40	230 - 2300	16 - 158	3/8" NPT(F)	3/8" NPT(F)
7694	2.5 - 10.5	9.5 - 40	400 - 4050	28 - 280	3/8" NPT(F)	3/8" NPT(F)
7630	2.0 - 10.5	8 - 40	400 - 5100	28 - 350	3/8" NPT(M)/BSP(F)	1/2" NPT(F)
7537	1.0 - 21	3.8 - 80	230 - 2600	16 - 179	1/2" NPT(F)	1/2" NPT(F)
7542	1.0 - 21	3.8 - 80	800 - 4000	55 - 275	1/2" NPT(F)	1/2" NPT(F)
7590	10 - 52	38 - 200	400 - 2175	28 - 150	1" NPT(F)	1" NPT(F)
7592	10 - 52	38 - 200	450 - 2500	31 - 175	1" NPT(F)	1" NPT(F)
7593	10 - 52	38 - 200	750 - 4050	51 - 280	1" BSPP(G)	1" BSPP(G)
9950	50 - 120	190 - 456	100 - 2900	6.9 - 200	1-1/4" BSP(F)	1-1/2" BSP(F)



BRASS, MODULAR, BUILT IN BYPASS, 3CP AND 5CP SERIES (Pressure Sensitive)

7850	0.5 - 6.0	1.9 - 23	100 - 4000	6.9 - 275	1/2" NPT(F)/3/8" NPT(M)	Modular - 3CP, 5CP
------	-----------	----------	------------	-----------	-------------------------	--------------------

* This unloader will not work on models 5CP4120, 5CP6120, 5CP6180CSS and 5CP6190 pumps.

STAINLESS STEEL MODELS

7501**	0.5 - 6.0	1.9 - 23	100 - 2000	6.9 - 138	3/8" NPT(M)	3/8" NPT(F)
9970*	0 - 15.9	0 - 60	1160 - 11600	80 - 800	1/2" BSPP(G)	1/2" BSPP(G)
7531*	1.0 - 21	3.8 - 80	400 - 2200	28 - 155	1/2" NPT(F)	1/2" NPT(F)
7533*	1.0 - 21	3.8 - 80	800 - 4000	55 - 275	1/2" NPT(F)	1/2" NPT(F)
7536*	1.0 - 21	3.8 - 80	3000 - 6000	207 - 414	1/2" NPT(F)	1/2" NPT(F)

* 304 Stainless Steel ** 316 Stainless Steel

CHECK OUT

Regulator Relief vs Unloader Valve Product Comparison

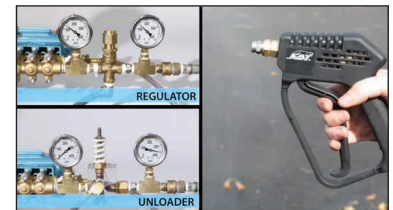

This product comparison video from Cat Pumps offers an in-depth look at one of our most common inquiries – the difference between a pressure regulator and pressure regulating unloader valve.

www.catpumps.com/youtube



TECH TIP

Converting Unloader into a Relief Valve

All trapped pressure unloaders can be configured as a pressure relief valve by removing the check valve from the discharge fitting. To order a relief valve, add ".100" at the end of the unloader part number.

Example: 7537 = Pressure Unloader and 7537.100 = Pressure Relief Valve.

Discharge Accessories

Primary or Secondary Pressure Control

Pressure Relief Valves

- Heavy duty; conveniently mounts directly into discharge line.
- Wide pressure and flow range models available.



MODEL	FLOW RANGE		PRESSURE RANGE		PORTS	
	gpm	lpm	psi	bar	Inlet/Discharge	Bypass

BRASS MODELS

7189	0.5 - 6.6	1.9 - 24.9	100 - 650	6.9 - 45	3/8" NPT(F)	3/8" NPT(F)
7190	0 - 6.5	0 - 24.6	400 - 5000	28 - 345	3/8" BSP(F)	3/8" BSP(F)

Note: All trapped pressure unloaders can be configured as a relief valve, see page 5.

316 STAINLESS STEEL MODELS, FLOW THROUGH

7034	0 - 21	0 - 80	400 - 2200	28 - 155	1/2" NPT(F)	1/2" NPT(F)
7036	0 - 21	0 - 80	800 - 4000	55 - 275	1/2" NPT(F)	1/2" NPT(F)
7037	0 - 21	0 - 80	3000 - 5700	207 - 400	1/2" NPT(F)	1/2" NPT(F)
890718	10 - 50	38 - 189	1000 - 8000	69 - 550	2" NPT(M)	2" NPT(F)
890709	20 - 60	76 - 227	1500 - 4000	103 - 275	2" NPT(F)	2" NPT(M)
890731	15 - 75	56 - 284	100 - 400	6.9 - 28	2" NPT(F)	2" NPT(M)
890700	30 - 180	114 - 680	1000 - 3000	69 - 207	2" NPT(F)	2" NPT(M)
890702	25 - 210	95 - 795	500 - 2000	35 - 138	2" NPT(F)	2" NPT(M)
890706	15 - 260	57 - 984	250 - 1000	17 - 69	2" NPT(F)	2" NPT(M)
890704	45 - 320	170 - 1211	500 - 2000	35 - 138	2" NPT(F)	2" NPT(M)

Note: All trapped pressure unloaders can be configured as a relief valve, see page 5.

BRASS MODELS, TEE MOUNT

7084*	1.0 - 3.5	3.8 - 13	100 - 600	6.9 - 41	1/4" BSP(M)	1/8" BSP(F)
7085*	1.0 - 3.5	3.8 - 13	205 - 2300	14 - 158	1/4" BSP(M)	1/8" BSP(F)
7561	0 - 4.0	0 - 15.1	100 - 1000	6.9 - 69	1/4" NPT(M)/NPT(F)	1/4" NPT(F)
7080	2.8 - 7.8	9.5 - 30	150 - 1450	10 - 100	3/8" NPT(F)	3/8" NPT(F)
7082	2.8 - 7.8	9.5 - 30	850 - 3575	59 - 246	3/8" NPT(F)	3/8" NPT(F)
997304	0 - 20	0 - 75.7	0 - 300	0 - 20	1/2" NPT(M)	1/2" NPT(F)
7196	0 - 21	0 - 80	100 - 7250	6.9 - 500	1/2" BSP(F)	3/8" BSP(F)
7595	1.0 - 53	3.8 - 200	260 - 2600	18 - 180	3/4" NPT(F)	1/2" NPT(F)

* Model 7084C & 7085C available with handles

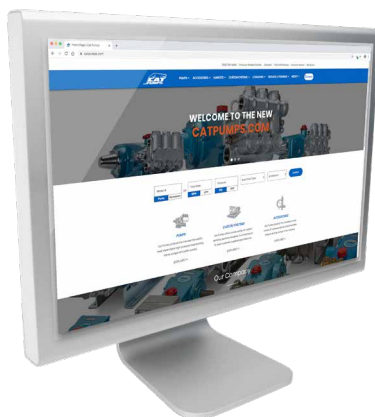

Need selection assistance?

Browse the complete Cat Pumps accessory catalog using the product selector at catpumps.com. Search by applicable information including model number, performance, material or product type.

You can also browse the training section to find system design, installation and maintenance information, as well as handy formulas and charts to assist in all phases of selection and design.

Secondary Pressure Control

Pop-Off Valves

- Opens when system exceeds preset pressure.
- Lightweight, compact design quickly and conveniently mounts directly into discharge line.
- Ultra compact models for portable systems.

MODEL	MAXIMUM FLOW		PRESSURE RANGE		MAX. RELIEF SETTING		PORTS	
	gpm	lpm	psi	bar	psi	bar	Inlet/Discharge	Bypass
BRASS MODELS								
30960	6.0	23	300 - 1500	20 - 103	1650	114	1/4" NPT(M)	3/4" Barb
33960	6.0	23	300 - 1500	20 - 103	1650	114	3/8" NPT(M)	3/4" Barb
33960S**	6.0	23	300 - 1500	20 - 103	1650	114	3/8" NPT(M)	3/4" Barb
30961	6.0	23	1000 - 3000	69 - 207	3300	228	1/4" NPT(M)	3/4" Barb
33961	6.0	23	1000 - 4000	69 - 275	4400	303	1/4" NPT(M)	3/4" Barb
33961S**	6.0	23	1000 - 4000	69 - 275	4400	303	1/4" NPT(M)	3/4" Barb
33962	6.0	23	1000 - 4000	69 - 275	4400	303	3/8" NPT(M)	3/4" Barb
33962S**	6.0	23	1000 - 4000	69 - 275	4400	303	3/8" NPT(M)	3/4" Barb
9940	25	95	1000 - 4000	69 - 275	4400	303	3/4" NPT(M)	1" Barb

316 STAINLESS STEEL MODELS

9960	6.0	23	300 - 1500	20 - 103	1650	114	1/4" NPT(M)	3/4" Barb
9960S**	6.0	23	300 - 1500	20 - 103	1650	114	1/4" NPT(M)	3/4" Barb
9961	6.0	23	1000 - 3000	69 - 207	3300	228	1/4" NPT(M)	3/4" Barb
9961S**	6.0	23	1000 - 3000	69 - 207	3300	228	1/4" NPT(M)	3/4" Barb
9962	6.0	23	1000 - 4000	69 - 275	4400	308	1/4" NPT(M)	3/4" Barb
9962S**	6.0	23	1000 - 4000	69 - 275	4400	308	1/4" NPT(M)	3/4" Barb
997587	15	57	1500 - 10000	105 - 689	11000	758	1/2" NPT(F)	1" NPT(F)
9941	25	95	1000 - 4000	69 - 275	4400	303	3/4" NPT(M)	1" Barb
890711	50	189	1000 - 6000	69 - 414	7500	517	1" NPT(M)	1" NPT(F)
890710	100	378	300 - 1500	20 - 103	1875	129	1" NPT(M)	1" NPT(F)
890714***	100	378	300 - 1500	20 - 103	1875	129	1" NPT(M)	1" NPT(F)
890715	100	378	1000 - 8000	69 - 550	10000	689	2" NPT(M)	2" NPT(F)
890712	115	435	500 - 3000	35 - 207	3750	258	1" NPT(M)	1" NPT(F)
890703	135	511	400 - 1500	28 - 103	1875	129	2" NPT(M)	2" NPT(F)
890713	210	795	500 - 4000	35 - 275	5000	345	2" NPT(M)	2" NPT(F)

** High-temperature models up to 240° F (115° C) ***NBR O-Rings

RUPTURE DISC ASSEMBLY

9920	20	76	15000	1034	—	—	3/8" NPT(M)/NPT(F)	3/8" NPT(F)
------	----	----	-------	------	---	---	--------------------	-------------

Rupture Disc Assembly (Used on models 1810, 1810K, 6810) – Opens at 15,000 psi



TECH TIP

Primary and Secondary Relief

Cat Pumps always recommends each high-pressure pumping system to be equipped with a primary and secondary safety relief device as a safeguard against over pressurization. Either a pressure regulator or pressure regulating unloader can be used as a primary relief device, but a pressure relief or pop-off valve should always be included when designing a system. This is an economical alternative to protect a system from failure that can damage expensive system components and lead to costly downtime.

Discharge Accessories



Pressure Gauges

Accurately monitors pump outlet pressure.

- Glycerine filled for consistent and accurate pressure readings.
- Sealed stainless steel case eliminates corrosion risk.

MODEL	PRESSURE RANGE		MAXIMUM TEMPERATURE (°F)	PORTS Inlet
	psi	bar		
BRASS MODELS (Brass Fitting and Bourdon Tube, 304 SS Case)				
6086	0 - 1500	0 - 103	140	1/4" NPT(M)
6094**	0 - 1500	0 - 103	140	1/8" NPT(M)
6088	0 - 3000	0 - 207	140	1/4" NPT(M)
6096**	0 - 3000	0 - 207	140	1/8" NPT(M)
6089	0 - 6000	0 - 415	140	1/4" NPT(M)
STAINLESS STEEL MODELS (316 SS Fitting and Bourdon Tube, 304 SS Case)				
6069	0 - 600	0 - 41	200	1/4" NPT(M)
6071	0 - 1500	0 - 103	300	1/4" NPT(M)
6085	0 - 1500	0 - 103	140	1/4" NPT(M)
6073	0 - 3000	0 - 207	300	1/4" NPT(M)
6097	0 - 3000	0 - 207	140	1/4" NPT(M)
6127	0 - 4000	0 - 275	140	1/2" NPT(M)
6076	0 - 6000	0 - 415	300	1/4" NPT(M)
6087	0 - 6000	0 - 415	140	1/4" NPT(M)
6081*	0 - 20000	0 - 1379	212	1/2" NPT(M)

* 316 SS Fitting and Bourdon Tube, black fiberglass reinforced case ** Back Mount



34549

Valve Plug Adapters

Used to directly mount pressure gauge to valve port

- Eliminates need for additional plumbing on discharge port

MODEL	MODELS USED	PORT	MATERIAL
134670	4DX, 4DNX, 4SPX, 4SP, 5SP	1/4" NPT (F)	BB
35758	66DX	3/8" NPT (F)	BB
998954	3CP Series	3/8" NPT (F)	BB
76658	310, 5CP2120, 2150W	3/8" NPT (F)	BB
34549	45, 5CP3105 - 3160CSS, 5120 - 5140	3/8" NPT (F)	BB
45939T	56-60	3/8" NPT (F)	BB
34447	7PFR, 15PFR, 5CP6120, 7CP	3/8" NPT (F)	BB
43848	1530	1/2" NPT (F)	FBB
76795	3507, 3517	1/4" NPT (F)	NAB
997878	3560	1/4" NPT (F)	BB
76678	3527, 3535, 3537, 3570	1/4" NPT (F)	NAB
76461	6760	1/4" NPT (F)	NABC

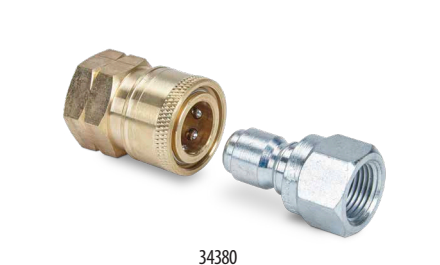

34380

Quick Disconnect Assemblies

Used to connect discharge hose to discharge hose.

- Straight thru flow design.

MODELS	MATERIAL	MAXIMUM		PORT
		PSI	BAR	
990469	Brass	2000	138	1/2"NPT(F) X 1/2"NPT(F)
34380	Brass	4000	275	3/8"NPT(F) X 3/8"NPT(F)
34381	Steel	10000	689	1/2"NPT(F) X 1/2"NPT(F)

Pulsation Dampeners

Used when a smooth output flow and pressure are required.

- Pressurized bladder absorbs impact from pressure spikes, providing smoother flow.
- Most models are field repairable and rechargeable.

MODEL	MAXIMUM FLOW		PRESSURE RANGE		BLADDER Material	VOLUME Cubic Inches	PRECHARGE psi	PORT Inlet
	gpm	lpm	psi	bar				
CARBON STEEL (UPPER BODY), 316 STAINLESS STEEL (LOWER BODY) RECHARGEABLE								
6029	15	57	100-3000	6.9-207	NBR	10	450	1/2" NPT(M)
6030	15	57	100-3000	6.9-207	FPM	10	450	1/2" NPT(M)
6011	25	95	100-7200	6.9-500	NBR	15	2000	1/2" NPT(F)
6018	40	151	100-3000	6.9-207	NBR	45	450	1" NPT(M)
6022	70	265	100-1500	6.9-103	NBR	120	450	1-1/4" NPT(M)

CARBON STEEL, SEALED

6026	15	57	300-600	20-41	NBR	10	250	1/2" NPT(M)
6028	15	57	600-1000	41-69	NBR	10	450	1/2" NPT(M)

316 STAINLESS STEEL, RECHARGEABLE

6032.800	10	38	0-10,000	0-689	NBR	15	Special	1/2" NPT(M)
6031	15	57	100-2400	6.9-168	NBR	10	450	1/2" NPT(M)
6014	25	95	100-2400	6.9-168	NBR	20	450	3/4" NPT(M)
6016	40	151	100-2000	6.9-138	NBR	45	450	1" NPT(M)
6013	40	151	100-2000	6.9-138	FPM	45	450	1" NPT(M)
6015	70	265	100-1500	6.9-103	NBR	120	450	1-1/4" NPT(M)

316 STAINLESS STEEL, RECHARGEABLE AND REBUILDABLE

701501	15	57	100-4300	6.9-296	NBR	6	No Precharge	1/2" NPT(F)
701521	15	57	100-4300	6.9-296	EPDM	6	No Precharge	1/2" NPT(F)
701541	15	57	100-4300	6.9-296	FPM	6	No Precharge	1/2" NPT(F)
701520	15	57	100-8300	6.9-572	NBR	6	No Precharge	1/2" NPT(F)
701535	15	57	100-8300	6.9-572	FPM	6	No Precharge	1/2" NPT(F)
701502	25	95	100-3800	6.9-265	NBR	15	No Precharge	1/2" NPT(F)
701542	25	95	100-3800	6.9-265	FPM	15	No Precharge	1/2" NPT(F)
701522	25	95	100-3800	6.9-265	EPDM	15	No Precharge	1/2" NPT(F)
701507	25	95	100-7100	6.9-490	NBR	15	No Precharge	1/2" NPT(F)
701537	25	95	100-7100	6.9-490	FPM	15	No Precharge	1/2" NPT(F)
701527	25	95	100-7100	6.9-490	EPDM	15	No Precharge	1/2" NPT(F)
701610	25	95	100-10,000	6.9-689	NBR	15	No Precharge	1/2" NPT(F)
701503	75	284	100-3000	6.9-207	NBR	30	No Precharge	1" NPT(F)
701543	75	284	100-3000	6.9-207	FPM	30	No Precharge	1" NPT(F)
701523	75	284	100-3000	6.9-207	EPDM	30	No Precharge	1" NPT(F)
701550	100	378	100-3365	6.9-232	NBR	122	No Precharge	1-1/2" NPT(F)
701555	100	378	100-6350	6.9-438	NBR	60	No Precharge	1" NPT(F)
701557	320	1211	100-1275	6.9-88	NBR	214	No Precharge	1-1/2" NPT(F)

Pulsation Dampener Ordering Information

For optimal performance, pulsation dampener pre-charge should be set accordingly:

- Rechargeable (6011 – 6031) should be preset at 50% of the operating pressure
- Rebuildable (701501 – 701610) should be preset to 75% of the operating pressure

To change the preset precharge, add a .800 to the part number and specify pre-charge pressure.



TECH TIP

Due to the design of positive displacement pumps, small pressure spikes are caused during each rotation. In certain operations, these spikes can cause accelerated wear or damage to the pump or downstream components. The installation of a pulsation dampener is the best practice to reduce pressure fluctuations.

Model 1530 w/o Pulsation Dampener

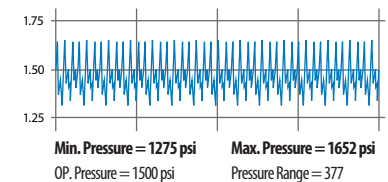

Model 1530 w/ Pulsation Dampener

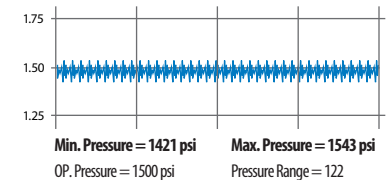

Pulsation Dampener Benefits:

- Produces smooth, consistent flow
- Protects downstream components (e.g., regulator, unloader, relief valve)
- Reduces water hammer
- Improved performance at low rpm

Inlet Accessories



Filters

Used to filter solid particulates in water.

- Flow from inside-to-outside allows sediment to collect inside the removable filter screen.
- Removable bowl permits easy cleaning without removing filter or plumbing.

MODEL	SUCTION/PRESSURIZED FLOW		SCREEN		PORTS	
	gpm	lpm	Mesh	Material	Inlet	Discharge
WHITE NYLON BODY						
7104*	6/10	23/38	80	S	1/2" NPT(F)	1/2" NPT(F)
7105*	15/20	57/76	80	S	3/4" NPT(F)	3/4" NPT(F)
7106*	20/25	76/95	80	S	1" NPT(F)	1" NPT(F)
7107*	35/50	133/189	80	S	1-1/4" NPT(F)	1-1/4" NPT(F)
7108*	60/75	227/284	80	S	1-1/2" NPT(F)	1-1/2" NPT(F)

CLEAR NYLON BODY

7104.4*	6/10	23/38	80	S	1/2" NPT(F)	1/2" NPT(F)
7105.5*	15/20	57/76	80	S	3/4" NPT(F)	3/4" NPT(F)
7106.6*	20/25	76/95	80	S	1" NPT(F)	1" NPT(F)
7107.7*	35/50	133/189	80	S	1-1/4" NPT(F)	1-1/4" NPT(F)
7108.8*	60/75	227/284	80	S	1-1/2" NPT(F)	1-1/2" NPT(F)

POLYPROPYLENE BODY (Y-INLINE)

7109	100/150	378/567	80	SS	2" NPT(F)	2" NPT(F)
------	---------	---------	----	----	-----------	-----------

WHITE NYLON BODY (MICRO)

7203	10 gpm max	38	80	S	1/2" NPT(M)	1/2" NPT(M)
7204	10 gpm max	38	80	S	1/2" NPT(F)	1/2" NPT(F)

CLEAR NYLON BODY (MICRO)

7203.3	10 gpm max	38	80	S	1/2" NPT(M)	1/2" NPT(M)
7204.4	10 gpm max	38	80	S	1/2" NPT(F)	1/2" NPT(F)

REINFORCED COMPOSITE BODY (w/ brass threaded ports, 1/4" BSP(F) auxiliary port)

32738	8 gpm max	30	50	SS	1/2" BSP(F)	1/2" BSP(M)
32748	8 gpm max	30	50	SS	1/2" BSP(F)	1/2" BSP(F)

S = 304 Stainless steel, SS = 316 Stainless steel Optional Mesh sizes available

*For suction applications refer to data sheets for inlet pressure losses -vs- flow to prevent cavitation.

Inlet Pressure Gauges

Accurately monitors pump inlet pressure.

- Glycerine-filled for consistent and accurate pressure readings.
- Sealed stainless steel case eliminates corrosion risk.



MODEL	MAXIMUM PRESSURE		PORTS Inlet
	psi	bar	
BRASS MODELS (Brass Fitting and Bourdon Tube, 304 SS Case)			
6082	100	6.9	1/4" NPT(M) Bottom
997901	400	28	1/4" NPT(M) Bottom

STAINLESS STEEL MODELS (316 SS Fitting and Bourdon Tube, 304 SS Case)

997068	160	11	1/4" NPT(M) Bottom
997336	160	11	1/4" NPT(M) Panel Mount
994063	400	28	1/2" NPT(M) Bottom

Note: Maximum inlet pressure is 70 psi on most pumps. Review pump data sheet.

Inlet Pressure Regulators

Used to set and maintain consistent pressure at pump inlet.

- Convenient, compact inline installation.
- Adjustable and non-adjustable models available.
- Improves pump performance.

MODEL	MAXIMUM FLOW		INLET PRESSURE		OUTLET PRESSURE		PORTS	
	gpm	lpm	psi	bar	psi	bar	Inlet	Outlet
BRASS - NONADJUSTABLE								
7069	10	38	40-200	3-14	30-45	2-3	3/4" FGH	3/4" MGH
7071	10	38	40-200	3-14	30-45	2-3	3/4" FGH	1/2" NPT(F)

STAINLESS STEEL - ADJUSTABLE								
7SS075	0-12	0-45	350	24	15-85	1.03-5.86	3/4" NPT(F)	3/4" NPT(F)
7SS100	0-20	0-76	350	24	15-85	1.03-5.86	1" NPT(F)	1" NPT(F)
7SS150	0-50	0-189	350	24	15-85	1.03-5.86	1-1/2" NPT(F)	1-1/2" NPT(F)
7SS200	0-75	0-284	350	24	15-85	1.03-5.86	2" NPT(F)	2" NPT(F)

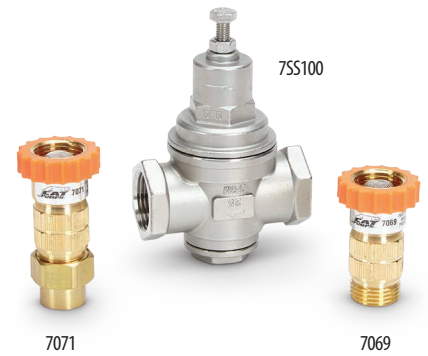

Inlet Stabilizers

Used to maintain consistent inlet pressure.

- Eliminates cavitation and potentially damaging surges and hydraulic spikes.
- Compact, easy installation with matching adapter assemblies.

MODEL	MAXIMUM FLOW		INLET PRESSURE RANGE		PORTS Adapter sizes available
	gpm	lpm	psi	bar	
STAINLESS STEEL					
711500	15	57	2.0-50	0.1-3.5	1/2", 3/4", 1", 1-1/4", 1-1/2"
714500	45	170	2.0-50	0.1-3.5	1", 1-1/4", 1-1/2", 2", 2-1/2"
717500	75	284	2.0-50	0.1-3.5	2", 2-1/2"
719500	320	1211	2.0-60	0.1-4.1	6" X ANSI 150, 6" elbow R150 Series Flange



Fitting Size	INLET STABILIZERS			
	711500	714500	717500	719500

STRAIGHT ADAPTER FITTINGS				
1/2" NPT(M)	711502			
3/4" NPT(M)	711503			
1" NPT(M)	711504	714504		
1-1/4" NPT(M)	711505	714505		
1-1/2" NPT(M)	711506	714506		
2" NPT(M)		714508	717508	
2-1/2" NPT(M)			717510	

ELBOW ADAPTER FITTINGS				
1-1/2"	701818			
2-1/2"		701828		
3"			701833	

Inlet Accessories



Thermal Valves

Reduces heat build-up in a closed-loop bypass system.

- Lightweight with three port size options for easy installation.
- Recommended when by-pass is redirected to pump inlet.

MODEL	TEMPERATURE MAX (°F)	PORTS		MAXIMUM FLOW		MAXIMUM PRESSURE	
		Inlet	Bleed	gpm	lpm	psi	bar

BRASS MODELS

7140	145	1/4" NPT(M)	1/8" NPT(F)	25	95	125	8.6
7141	145	3/8" NPT(M)	1/8" NPT(F)	25	95	125	8.6
7142	145	1/2" NPT(M)	1/8" NPT(F)	25	95	125	8.6
7143	165	1/4" NPT(M)	1/8" NPT(F)	25	95	125	8.6
7144	165	3/8" NPT(M)	1/8" NPT(F)	25	95	125	8.6
7145	165	1/2" NPT(M)	1/8" NPT(F)	25	95	125	8.6
7146	130	1/4" NPT(M)	1/8" NPT(F)	25	95	125	8.6
7170	180	1/4" NPT(M)	1/8" NPT(F)	25	95	125	8.6
7171	180	3/8" NPT(M)	1/8" NPT(F)	25	95	125	8.6
7172	180	1/2" NPT(M)	1/8" NPT(F)	25	95	125	8.6
7175	190	1/4" NPT(M)	1/8" NPT(F)	25	95	125	8.6
7176	190	3/8" NPT(M)	1/8" NPT(F)	25	95	125	8.6
7177	190	1/2" NPT(M)	1/8" NPT(F)	25	95	125	8.6

BRASS-MICRO MODELS

7116	145	3/8" BSP(M)	7 mm	25	95	145	10.0
------	-----	-------------	------	----	----	-----	------

REINFORCED COMPOSITE MODELS

7128	165	1/4" NPT(M)	1/8" NPT(F)	25	95	125	8.6
7129	165	3/8" NPT(M)	1/8" NPT(F)	25	95	125	8.6
7130	165	1/2" NPT(M)	1/8" NPT(F)	25	95	125	8.6
7135	145	1/4" NPT(M)	1/8" NPT(F)	25	95	125	8.6
7136	145	3/8" NPT(M)	1/8" NPT(F)	25	95	125	8.6
7137	145	1/2" NPT(M)	1/8" NPT(F)	25	95	125	8.6
7138	130	1/4" NPT(M)	1/8" NPT(F)	25	95	125	8.6



941516

Garden Hose Assemblies

Used to connect garden hose to pump inlet port.

- Convenient swivel for easy inlet connection.
- Inlet screen for filtering.

MODELS	MATERIAL	USED ON PUMP MODELS	PORT
941516	Brass	4DX Series, 4DNX Series, 4SP	3/8" NPT(M)
941517	Brass	4SF Series, 66DX Series, 5CP, 5SP	1/2" NPT(M)

Specialty Accessories

Quick-Start Valve

Designed to relieve pump discharge line pressure during system start-up.

- Use with a pressure lock-up style unloader (install after unloader).
- Requires less engine or motor start-up power.

MODEL	MAXIMUM FLOW		MAXIMUM PRESSURE		OPENING PRESSURE		INLET PORT	BARB
	gpm	lpm	psi	bar	psi	bar		
7126	8.0	30	4050	280	105	7.25	3/8" NPT(M)	1/4"



7126

Throttle Control

Reduces engine wear and fuel consumption by lowering rpm when pump is in bypass.

- Can be used on any size gas engine.
- Used with pressure regulating unloaders.

MODEL	MAXIMUM PRESSURE		ACTUATION PRESSURE		INLET PORT
	psi	bar	psi	bar	
8100	4000	275	250	18	3/8" NPT(M)



8100

MAG-JET and Pulsator Assemblies

Converts water-pressure pump to a water-jetting pump.

- Eliminates traditional dry pumping chamber that causes damage to pump.
- Easily mounts in the manifold inlet plug on most Cat Pumps models.

MODEL	USED ON PUMP MODELS
MAG-JET ASSEMBLIES	
31804	3CP1120, 3CP1120G, 3CP1130, 3CP1140
31810	56, 56G1, 57, 60, 60G1, 5CP5140CSS
31814	310, 340, 350, 5CP2120W, 5CP2140WCS, 5CP2150W
31815	45, 45G1, 5CP3120, 5CP3120CSS, 5CP3120CSSG1, 5CP5120, 5CP5135CSSG1
31845	660, 1050, 5CP6120, 7CP6110CS, 7CP6170
PULSATOR ASSEMBLIES	
34455	2SFX Series Pumps
76560	1560
35450	66DX
34451	56, 57, 60
34458	5CP3120 - 5140
34448	15FR, 7CP

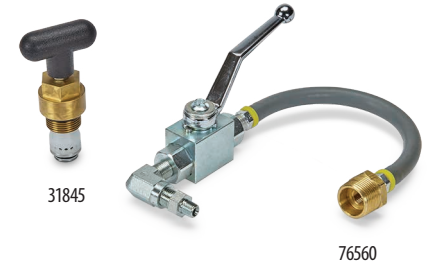

31845

76560

Flow Switches

Flow control device used to shut down pump when trigger on gun is released.

- Mount to discharge fitting of unloader to monitor when gun is open or closed.
- Use in conjunction with a relay switch.

MODEL	FLOW RANGE		MAXIMUM PRESSURE		MAXIMUM Voltage	PORTS
	gpm	lpm	psi	bar		
BRASS MODELS						
33786	1.6 - 8	6 - 30	5100	350	230	3/8" BSP(F)
33776	1.3 - 7	5 - 26	3500	240	250	3/8" BSP(M)



33786

33776

Specialty Accessories



34870

Auto Shut-Off Assemblies

Used to automatically shut system off when trigger gun is released or nozzle is closed.

- Assembly includes a pair of pressure switches, mechanical relay, electrical box and toggle switch.
- Higher horsepower units use a magnetic motor starter and overload heaters.

MODEL	HORSEPOWER/ PHASE	MAXIMUM VOLTS	PRESSURE SWITCH MODELS	MECHANICAL RELAY MODEL	STARTER
34870	2/1	115	31615, 31625	34542	NA
34871	3/1	220	31615, 31625	34543	NA



30664.120VAC

LPS Monitors

Designed to sense water leakage past the low-pressure seals.

- Can configure the monitor to PLC or PC based systems.
- Light option to alert maintenance personnel when pump seal replacement is required.

MODEL	USED ON PUMP MODELS
PLC/PC INTERFACE FOR 15 AND 18 FRAME PLUNGER PUMPS	
30664	Plunger pumps: 650 thru 1810K
INDICATOR LIGHT FOR 15 AND 18 FRAME PLUNGER PUMPS	
30664.120AC, 30664.240AC	Plunger pumps: 650 thru 1810K
PLC/PC INTERFACE FOR 25 FRAME PISTON, 25, 28, 35 AND 38 FRAME PLUNGER PUMPS	
30290, 30292	Piston pump: 2520 Plunger pumps: 2530 thru 2831K, 3501 thru 3570, 3801 thru 3841K
INDICATOR LIGHT FOR 25 FRAME PISTON, 25, 28, 35 AND 38 FRAME PLUNGER PUMPS	
30290.120AC	Piston pump: 2520 Plunger pumps: 2530 thru 2831K, 3501 thru 3570, 3801 thru 3841K



31013

32010

Float Valves

Maintains adequate liquid level in reservoir to provide consistent flow to pump inlet.

- Adjustable or preset models available.
- Compact and easy to install.

MODEL	MAXIMUM FLOW gpm	MAXIMUM FLOW lpm	MAXIMUM INLET PRESSURE psi	MAXIMUM INLET PRESSURE bar	INLET PORT	INTERNAL BODY
ADJUSTABLE						
31013	7.1	27	145	10	3/8" BSP(M)	Brass
PRESET						
32010	8.0	30	145	10	3/4" BSP(M)	Polyethylene

Pressure Switches

Pressure-activated control device to control on-off operation of low amp system components.

- Non-adjustable, preset pressure setting for consistent system protection.
- 3 wire construction for either normally open or normally closed operation.



MODEL	MAXIMUM PRESSURE		ENGAGING PRESSURE		VOLTAGE RANGE	MAXIMUM AMP	INLET PORT
	psi	bar	psi	bar			
STAINLESS STEEL - NPT PORTS							
31615	3650	250	215	15	12 - 250	6	1/4" NPT(M)
31625	3650	250	360	25	12 - 250	6	1/4" NPT(M)
31640	3650	250	580	40	12 - 250	6	1/4" NPT(M)

Custom Pumping Systems

YOU DEFINE. WE DESIGN AND DELIVER.

Cat Pumps is the industry leader in providing quality custom-engineered pumping systems. Each custom system is built to meet the needs of the individual customer, backed by the expertise of the Cat Pumps technical sales and engineering team. Our team assists in all phases of the build, including gathering application information, component/configuration selection, building, testing, and after-sales support.

Purchasing a custom system from Cat Pumps offers more benefits than simply providing a high quality pumping system.

By choosing Cat Pumps for your next custom system need, you save the time and expense of the following tasks:

- Initial Design
- Multiple Source Buying and Receiving
- Assembly
- Testing and Validation
- System Documentation
- Packaging

With thousands of installations operating around the world, choose Cat Pumps for your next custom pumping system.

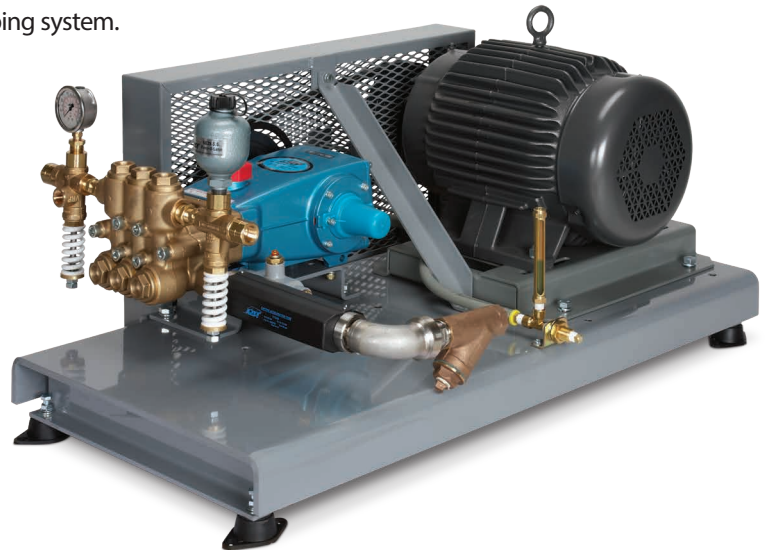

Operator Controls



Guns and Lance Assemblies

Ergonomic construction with smooth trigger action-reducing operator fatigue.

- Special safety lock to prevent unintentional operation.
- Stainless Steel seat and ball for thousands of continuous cycles.

MODEL	MAXIMUM FLOW		MAXIMUM PRESSURE		TYPE	PORTS	
	gpm	lpm	psi	bar		Inlet	Discharge
BRASS (internal body)							
33425	8	30	2900	200	Front Load	3/8" NPT(F)	1/4" NPT(F)
76168	8	30	4000	275	Weep	3/8" NPT(F)	1/4" NPT(F)
76165	8	30	4000	275	Shut-off	3/8" NPT(F)	1/4" NPT(F)
35150	8	30	5000	345	Shut-off	3/8" NPT(F)	1/4" NPT(F)
35151	8	30	5000	345	Weep	3/8" NPT(F)	1/4" NPT(F)
31260	8	30	5100	350	Pressure Compensating	3/8" NPT(F)	1/4" NPT(F)
32300	10	38	3000	207	Dump	3/8" NPT(F)	1/8" NPT(F)
32301	10	38	3000	207	Dump	3/8" NPT(F)	1/8" NPT(F)
31137	10	38	4500	310	Horizontal	3/8" NPT(F)	1/4" NPT(F)
31811	10.5	40	4500	310	Shut-off	3/8" NPT(F)	1/4" NPT(F)
36140	10.5	40	5000	345	Shut-off	3/8" NPT(F)	1/4" NPT(F)
36141	10.5	40	5000	345	Weep	3/8" NPT(F)	1/4" NPT(F)
992641	10.5	40	14,500	999	Shut-off	3/8" BSP(F)	3/8" BSP(F)
31265	13	49	3650	252	Pressure Compensating	3/8" NPT(F)	1/4" NPT(F)
39410	21	80	7250	500	Shut-off	1/2" BSP(F)	1/2" BSP(F)
39415	32	121	1750	120	Shut-off	1/2" BSP(F)	1/2" BSP(F)
39420	53	200	2900	200	Shut-off	1/2" BSP(F)	1/2" BSP(F)
STAINLESS STEEL (internal body)							
36126	10	38	4000	275	Shut-off	3/8" NPT(F)	1/4" NPT(F)
33600	10.5	40	5800	400	Pressure Compensating	3/8" NPT(F)	1/4" NPT(F)
BRASS GUN WITH STAINLESS STEEL LANCE							
39411	21	80	7250	500	Shut-off w/16" Lance	1/2" BSP(F)	1/4" NPT(F)
39412	21	80	7250	500	Shut-off w/32" Lance	1/2" BSP(F)	1/4" NPT(F)
39422	21	80	7250	500	Shut-off w/50" Lance	1/2" BSP(F)	1/4" NPT(F)
39440	32	121	1750	120	Shut-off w/32" Lance	1/2" BSP(F)	1/4" NPT(F)

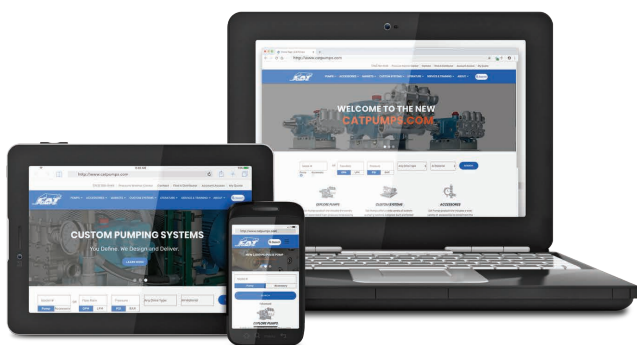

Catpumps.com

Web-based resource center for Cat Pumps.

- Keep current about "What's New"
- Product selector for pumps and accessories
- 2D/3D CAD drawings
- Troubleshooting and service videos
- Product training
- Complete sales and technical literature library
- Distributor search

Lances

A variety of lance types, lengths and materials ready to install to any 1/4" gun.

- Ventilated insulator for operator comfort and safety.
- Durable nozzle protector reducing nozzle and property damage.

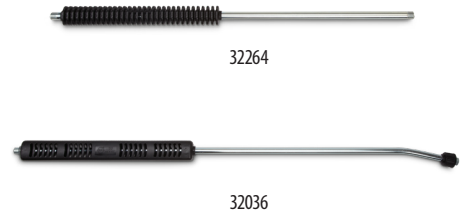

MODEL	MAXIMUM FLOW		MAXIMUM PRESSURE		LENGTH		PORTS	
	gpm	lpm	psi	bar	Inches	mm	Inlet	Discharge
ZINC PLATED STRAIGHT TUBE WITH HAND GRIP								
32264	10.5	40	3650	252	24	600	1/4" BSP(M)	1/4" BSP(M)
36267	10.5	40	3650	252	36	900	1/4" BSP(M)	1/4" BSP(M)
32268	10.5	40	3650	252	48	1200	1/4" BSP(M)	1/4" BSP(M)

ZINC PLATED TUBE WITH VENTED GRIP AND NOZZLE PROTECTOR								
31017	10.5	40	3650	252	27	900	1/4" BSP(M)	1/4" NPT(F)
33201 *	10.5	40	3650	252	35	890	1/4" BSP(M)	1/4" BSP(F)
32036	10.5	40	3650	252	36	900	1/4" NPT(M)	1/4" NPT(F)
32031	10.5	40	3650	252	36	900	1/4" BSP(M)	1/4" NPT(F)
32032	10.5	40	3650	252	48	1200	1/4" BSP(M)	1/4" NPT(F)

* Dual Lance

STAINLESS STEEL TUBE WITH VENTED GRIP AND NOZZLE PROTECTOR								
31219	8	30	5100	350	32	812	1/4" NPT(M)	1/4" NPT(F)
31220	8	30	5100	350	42	1065	1/4" NPT(M)	1/4" NPT(F)
32042	10.5	40	3650	252	36	900	1/4" NPT(M)	1/4" NPT(F)
33200 *	10.5	40	3650	252	43	1090	1/4" BSP(M)	1/4" BSP(F)

* Dual Lance

LANCE ASSEMBLY								
32437 **	21	80	7250	500	16	406	1/2" BSP(M)	1/4" NPT(F)
32438 **	21	80	7250	500	32	812	1/2" BSP(M)	1/4" NPT(F)
39194**	21	80	7250	500	50	1270	1/2" BSP(M)	1/4" NPT(F)
32440**	32	121	1750	120	32	812	1/2" BSP(M)	1/4" NPT(F)

** 304 Stainless steel

Industry Leading Customer Service

Cat Pumps knowledgeable and experienced customer service team provides assistance with order information, as well as technical support in product selection, installation, maintenance, pump repair and general system troubleshooting.

Support is available M – F, 8:00 a.m. to 5:00 p.m. CST at (763) 780-5440.

Email: techsupport@catpumps.com

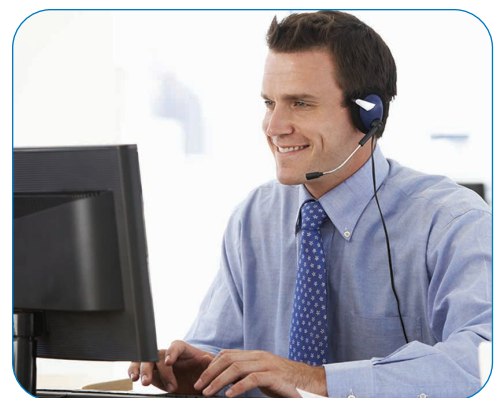

Operator Controls



Nozzles

Applicator/orifice defines rate and pattern of fluid.

- Easily mounts to a 1/4" lance.
- Nozzle types available: change over, rotating and turbo.
- Durable ceramic nozzle/insert for greater resistance to wear.

MODELS	MAXIMUM FLOW		MAXIMUM PRESSURE		PORT
	gpm	lpm	psi	bar	
CHANGE OVER NOZZLE WITH TWO 1/4" NPT(F) NOZZLE HOLDERS					
32149	7	26	2900	200	1/4" BSP(F)

MODELS	NOZZLE SIZE	FLOW RANGE		PRESSURE RANGE		PORT
		gpm	lpm	psi	bar	
TURBO-NOZZLES 3000 PSI MAX						
7265.20	2.0	1.1 - 1.7	4.1 - 6.4	1200 - 3000	83 - 207	1/4" BSP(F)
7265.30	3.0	1.6 - 2.6	6.0 - 9.8	1200 - 3000	83 - 207	1/4" BSP(F)
7265.35	3.5	1.9 - 3.0	7 - 11.4	1200 - 3000	83 - 207	1/4" BSP(F)
7265.40	4.0	2.2 - 3.5	8.3 - 13	1200 - 3000	83 - 207	1/4" BSP(F)
7265.45	4.5	2.4 - 3.9	9 - 14.8	1200 - 3000	83 - 207	1/4" BSP(F)
7265.50	5.0	2.8 - 4.4	10.6 - 16.7	1200 - 3000	83 - 207	1/4" BSP(F)
7265.55	5.5	3.0 - 4.8	11.1 - 18.2	1200 - 3000	83 - 207	1/4" BSP(F)
7265.60	6.0	3.2 - 5.2	12.1 - 19.7	1200 - 3000	83 - 207	1/4" BSP(F)
7265.65	6.5	3.6 - 5.7	13.6 - 21.6	1200 - 3000	83 - 207	1/4" BSP(F)
TURBO-NOZZLES 5000 PSI MAX						
7270.45	4.5	3.0 - 5.0	11.4 - 18.9	2000 - 5000	138 - 345	1/4" BSP(F)
7270.55	5.5	3.8 - 6.2	14.4 - 23.5	2000 - 5000	138 - 345	1/4" BSP(F)
7270.65	6.5	4.6 - 7.3	17.4 - 27.6	2000 - 5000	138 - 345	1/4" BSP(F)
7270.80	8.0	5.6 - 8.9	21.2 - 33.7	2000 - 5000	138 - 345	1/4" BSP(F)
7270.90	9.0	6.4 - 10	24.2 - 37.9	2000 - 5000	138 - 345	1/4" BSP(F)
ROTATING NOZZLES 3650 PSI MAX						
7625.30	3.0	1.6 - 2.9	6.1 - 11	1200 - 3650	83 - 252	1/4" BSP(F)
7625.35	3.5	1.9 - 3.3	7.2 - 12.5	1200 - 3650	83 - 252	1/4" BSP(F)
7625.40	4.0	2.2 - 3.8	8.3 - 14.4	1200 - 3650	83 - 252	1/4" BSP(F)
7625.45	4.5	2.4 - 4.3	9.1 - 16.3	1200 - 3650	83 - 252	1/4" BSP(F)
7625.50	5.0	2.8 - 4.8	10.6 - 18.2	1200 - 3650	83 - 252	1/4" BSP(F)
7625.55	5.5	3.0 - 5.2	11.4 - 19.7	1200 - 3650	83 - 252	1/4" BSP(F)
7625.60	6.0	3.2 - 5.7	12.1 - 21.6	1200 - 3650	83 - 252	1/4" BSP(F)
7625.65	6.5	3.6 - 6.2	13.6 - 23.5	1200 - 3650	83 - 252	1/4" BSP(F)
7625.70	7.0	3.8 - 6.7	14.4 - 25.4	1200 - 3650	83 - 252	1/4" BSP(F)
7625.80	8.0	4.4 - 7.7	16.7 - 29.1	1200 - 3650	83 - 252	1/4" BSP(F)
ROTATING NOZZLES 5100 PSI MAX						
7632.35	3.5	2.8 - 3.9	10.6 - 14.8	2600 - 5100	180 - 350	1/4" BSP(F)
7632.40	4.0	3.2 - 4.5	12.1 - 17	2600 - 5100	180 - 350	1/4" BSP(F)
7632.45	4.5	3.6 - 5.1	13.6 - 19.3	2600 - 5100	180 - 350	1/4" BSP(F)
7632.50	5.0	4.0 - 5.6	15.1 - 21.2	2600 - 5100	180 - 350	1/4" BSP(F)
7632.55	5.5	4.4 - 6.2	16.7 - 23.5	2600 - 5100	180 - 350	1/4" BSP(F)
7632.60	6.0	4.8 - 6.7	18.2 - 25.4	2600 - 5100	180 - 350	1/4" BSP(F)
7632.65	6.5	5.2 - 7.3	19.7 - 27.6	2600 - 5100	180 - 350	1/4" BSP(F)
7632.70	7.0	5.6 - 7.9	21.2 - 29.9	2600 - 5100	180 - 350	1/4" BSP(F)

Need selection help?

If psi and nozzle gpm is known, then nozzle number can be calculated as follows:

$$\text{Nozzle number} = \text{gpm} \times \sqrt{\frac{4000}{\text{psi}}}$$

If psi and nozzle number is known, then gpm can be calculated as follows:

$$\text{gpm} = \text{nozzle number} \times \sqrt{\frac{\text{psi}}{4000}}$$

If gpm and nozzle number is known, then psi can be calculated as follows:

$$\text{psi} = \left(\frac{\text{gpm}}{\text{nozzle number}}\right)^2 \times 4000$$

A nozzle selection chart can also be found online at catpump.com in the reference documents section.

Vari-Nozzles

Used with downstream chemical injector to apply chemical at low pressure.

- Adjusts spray angle from 0° to 60° for cleaning flexibility.
- Color coded ID plug for easy identification.

MODELS	NOZZLE SIZE	FLOW RANGE		PRESSURE RANGE		PORT
		gpm	lpm	psi	bar	
VARI-NOZZLES						
7920	2.0	1.0-1.9	3.8-7.2	100-3650	6.9-252	1/4" BSP(F)
7930	3.0	1.5-2.9	5.7-10.8	100-3650	6.9-252	1/4" BSP(F)
7935	3.5	1.8-3.3	6.6-12.6	100-3650	6.9-252	1/4" BSP(F)
7940	4.0	2.0-3.8	7.8-14.4	100-3650	6.9-252	1/4" BSP(F)
7945	4.5	2.2-4.3	8.3-16.3	100-3650	6.9-252	1/4" BSP(F)
7950	5.0	2.5-4.7	9.5-17.8	100-3650	6.9-252	1/4" BSP(F)
7955	5.5	2.8-5.2	10.6-19.7	100-3650	6.9-252	1/4" BSP(F)
7960	6.0	3.0-5.6	11.4-21.2	100-3650	6.9-252	1/4" BSP(F)
7970	7.0	3.5-6.6	13.2-25.0	100-3650	6.9-252	1/4" BSP(F)



7920

Foamers

Draws chemical and air to create thick foam.

- Lance and chemical bottle can be fitted to a standard 1/4" gun.
- Convenient chemical injector adjustment knob or handle for adjusting chemical draw.
- Stainless Steel orifice and FPM O-rings for chemical compatibility.

MODELS	FLOW RANGE		PRESSURE RANGE		TYPE	PORT
	gpm	lpm	psi	bar		
FOAMER, WITH AND WITHOUT BOTTLE						
32017	2 - 4	7.6 - 15.2	750 - 2900	52 - 200	W/O Bottle	1/4" BSP(F)
39234	2 - 4	7.6 - 15.2	750 - 2900	52 - 200	W/1 Liter Bottle	1/4" BSP(F)
39196	2 - 4	7.6 - 15.2	750 - 2900	52 - 200	W/2 Liter Bottle	1/4" BSP(F)



39234

Operator Controls



7192

Chemical Injectors

Provides and regulates chemicals into pump stream.

- Must be used with change-over or adjustable nozzle to activate chemical draw with reduced downstream pressures.
- Mount directly to unloader or in-line on discharge plumbing.

MODEL	ORIFICE SIZE mm	FLOW RANGE		MAXIMUM PRESSURE		PORTS	
		gpm	lpm	psi	bar	Inlet	Discharge

BRASS - ADJUSTABLE

7182	1.8 mm	2 - 4	7.6 - 15	3500	241	3/8" NPT(M)	3/8" NPT(M)
7192	1.8 mm	2 - 4	7.6 - 15	3500	241	M18 x 1.0	3/8" NPT(M)
7183	2.1 mm	3 - 5	11.4 - 19	3500	241	3/8" NPT(M)	3/8" NPT(M)
7193	2.1 mm	3 - 5	11.4 - 19	3500	241	M18 x 1.0	3/8" NPT(M)
7184	2.3 mm	3 - 6	11.4 - 23	3500	241	3/8" NPT(M)	3/8" NPT(M)
7194	2.3 mm	3 - 6	11.4 - 23	3500	241	M18 x 1.0	3/8" NPT(M)
7224	2.3 mm	3 - 6	11.4 - 23	3500	241	M22 x 1.5	3/8" NPT(M)

BRASS - FIXED

7231	1.8 mm	2.0	7.6	3145	217	M18 x 1.0	3/8" NPT(M)
7242	2.0 mm	2.9	12.9	2500	175	M18 x 1.0	3/8" NPT(M)
7232	2.1 mm	3.0	11.4	3145	217	M18 x 1.0	3/8" NPT(M)
7332	2.1 mm	3 - 4	11.4 - 15	3000	207	M18 x 1.0	3/8" NPT(M)
7243	2.1 mm	3 - 5	11.4 - 19	4000	275	M22 x 1.5	3/8" NPT(M)
7367	2.1 mm	3 - 5	11.4 - 19	4000	275	M20 x 1.0	3/8" NPT(M)

STAINLESS STEEL - ADJUSTABLE

7722	1.8 mm	2 - 4	7.6 - 15	3500	241	3/8" NPT(M)	3/8" NPT(M)
7723	2.1 mm	3 - 5	11.4 - 19	3500	241	3/8" NPT(M)	3/8" NPT(M)
7724	2.3 mm	3 - 6	11.4 - 23	3500	241	3/8" NPT(M)	3/8" NPT(M)



Pulse Pumps

High-pressure injection downstream from the system pump.

- Eliminates harsh chemicals passing through pump.
- Simple field retrofit of existing pumps.

MODEL	MAXIMUM FLOW		MAXIMUM PRESSURE		PORTS	
	gpm	lpm	psi	bar	Inlet/Discharge	Manifold

PULSE PUMPS FOR PISTON PUMPS

6300	.25	1	1000	69	1/4" NPT(M)	1/2" NPT(M)
6305	1	3	1000	69	3/8" NPT(M)	3/4" NPT(M)

MODEL	FLOW RANGE		PRESSURE RANGE		PORTS	
	gph	lph	psi	bar	Inlet	Discharge

PULSE PUMPS FOR PLUNGER AND PISTON PUMPS

6340	1.0 - 10.5	3.8 - 40.0	100 - 2000	6.9 - 138	1/4" NPT(F) (Pump)	1/8" NPT(F) (Chemical)
6350	1.0 - 12	3.8 - 45.4	500 - 3000	35 - 207	1/4" Hose Barb	1/8" NPT(F)

Note: Contact Cat Pumps for selection of Adapter Assembly to fit your pump model.

Lubrication Accessories

Crankcase Oil

Genuine Cat Pumps crankcase oil provides maximum life and performance.

- Custom blend, premium grade, petroleum-based hydraulic oil for all Cat Pumps.
- Anti-wear additives protects metal-to-metal drive surfaces, extending drive life.
- High oxidative and chemical stability resists deposit formations and provides consistent fluid performance.
- Premium anti-corrosion additives offer protection in the most demanding operating environments.



6107

PART NUMBER	CAPACITY	PUMP MODELS
OIL		
6107	Bottle - 21 ounces	All piston and plunger pumps
6100	Case - 12-21 ounce bottles	All piston and plunger pumps
6102	Jug - 2.5 gallons	All piston and plunger pumps
6105	Twin pack - 2 x 2.5 gallons	All piston and plunger pumps
6109	Drum - 30 gallons	All piston and plunger pumps
6115	Pail - 5 gallons	152R060/C, 152R080/C, 152R100/C, 157R060/080
6116	Drum - 16 gallons	152R060/C, 152R080/C, 152R100/C, 157R060/080
997657	Jug - 1 gallon	All piston and plunger pumps - Food Grade
997638	Case - 4 x 1 gallon	All piston and plunger pumps - Food Grade

OILERS GRAVITY FEED WITH 1/4" NPT(M) THREADS

30278	1 ounce	2520/C, 2510/11, 2530-2537, Except 2831/K, 35/38 Series, Except 3541/C, 3545, 3841/K
30429	10 ounces	6020, 6040, 6760-6777, Except 6747 6861/K, Except 6801/K-6841/K

Gear Lube

Maximize life with genuine Cat Pumps Gear Lube.

- Low friction and operating temperature for low wear, extending gear box life.
- Anti-wear, anti-rust, anti-corrosion formulation to extend gearbox life.
- Excellent oxidation and thermal stability extends fluid life.
- Used on all Cat Pumps gearbox pumps except 3CP1120G and 3CP1211G (crankcase oil is used instead of Gear Lube).



6110

PART NUMBER	CAPACITY	PUMP MODELS
GEARLUBE		
6110	Bottle - 16 ounces	45G1, 56G1, 60G1, 700G1, 740G1, 760G1, 781G1, 5CP3120CSSG1, 5CP3160CSSG1, 5CP5135CSSG1, 5CP5140CSSG1, 5CP5140CSSG118, 5CP6120CSSG1, 5CPQ6221G1, 5CPQ6241CSG1, 5CPQ6251G1, 5CP6190G1, 7CP6110CSG1, 7CP6111CSG1, 7CP6170G1
6111	Case, 12-16 ounce bottles	

Lubrication Accessories



Anti-Seize and Sealants

Sealant and anti-seize ensure proper pump operation.

- Anti-Seize protects metal-to-metal surfaces from galling, seizing, friction and wear.
- Sealant is used to fill between mating surfaces within the manifold.

PART NUMBER	CAPACITY	PUMP MODELS
ANTI-SEIZE AND SEALANTS		
6106	2 milliliters	Anti-seize for pump shafts and keys - all plunger pumps
6119	2 ounces	Anti-seize for threads - all stainless steel plunger pumps
6124	3 ounces	Liquid gasket for o-rings, seals - all plunger pumps



Pump Protector

The Ultimate Protection for Long-Term Storage of Pressure Washer Pumps.

The best solution: use specially formulated Pump Protector from Cat Pumps to protect your pressure washer pump from freezing, corrosion, mineral deposits and premature wear. Recommended for use with all pressure washers, Pump Protector adds lubrication to pistons, valves and seals to prevent sticking.

PART NUMBER	CAPACITY	PUMP MODELS
PUMP PROTECTOR		
6208	Case = 6 - 12 oz bottles	All pressure washer pump models
How to Order: Order part number 6208 for a case of six bottles; 12 fluid ounces (355 ml) each		

Pump Accessories

Oil Drain/Level Indicator Kits

Easily monitor crankcase oil level at-a-glance and improve pump maintenance.

- Conveniently monitor oil when existing bubble gauge is obscured.
- Oil drain kit can be mounted at desired location for easy maintenance.

MODEL	USED ON PUMP MODELS
OIL LEVEL INDICATOR	
76144	Piston pumps: 2520 thru 6041 Plunger pumps: 2510 thru 6861K. EXCEPT 35 and 38 Frame series
OIL LEVEL INDICATOR W/DRAIN KIT	
76334	All Piston and Plunger pumps and 66DX, EXCEPT Plunger pumps 2SF, 2SFX, 4DX, 4DNX, 4SF, 4SP, 4SPX and 5SP series
76074	All stainless steel or nickel aluminum bronze pumps, EXCEPT Plunger pumps 2SF, 2SFX, 4DX, 4DNX, 4SF, 4SP, 4SPX and 5SP series and 66DX series
DRAIN KITS	
34314	Piston pumps: 6020 thru 6041 Plunger pumps: 3501 thru 3570, 3801 thru 3841K, 6747 Thru 6775 and 6801 thru 6861K
34334	All piston and plunger pumps and 66DX, EXCEPT plunger pumps 2SF, 2SFX, 4DX, 4DNX, 4SF, 4SP, 4SPX and 5SP series
990394	Plunger pumps: 2SF, 2SFX, 4DX, 4DNX, 4SF, 4SP, 4SPX and 5SP series



76334

Protectors – Shaft and Oil Cap

Safety devices to eliminate exposure to rotating pump shaft and to minimize water leakage into pump.

- Shaft protector not included with pump unless otherwise noted.
- Oil cap protector not included with pump except 35/38 series pumps.

PART NUMBER	MATERIAL	PUMP MODELS
SHAFT PROTECTORS		
25130	STCP	230-277, 280, 290, 333, 430
26516	STCP	2520/C, 2510/11, 2530-2537, 2831/K
29445	AL	6020, 6040, 6747, 6760-6775, 6801/K, 6811/K, 6821/K, 6831/K, 6841/K, 6861/K, 67070, 67102 Included with pump
30764*	NY	650, 660, 1050, 1530, 1540E, 1560, 1570, 1580 (6 mm Holes)
30764S*	NY**	661C, 661D, 1051, 1051C, 1051D, 1057, 1531, 1541, 1541C (6 mm Holes)
855046*	NY	650, 660, 1050, 1530, 1540E, 1560, 1570, 1580 Included with pump (8 mm Holes)
855047*	NY**	661C, 661D, 1051, 1051C, 1051D, 1057, 1531, 1541, 1541C Included with pump (8 mm Holes)
43139	STCP	621, 623, 820, 821, 1010, 1011
43256	STCP	530, 550
855042	NY	3501/C, 3507/C, 3511/C, 3517/C, 3520/C, 3521DHS/C, 3527, 3531D/C, 3535/C, 3537, 3541D/C, 3545, 3550, 3560, 3570, 3801/K, 3811/K, 3821HS/KHS, 3831/K, 3841/K Included with pump
118672	STCP	310-350S, 311-357, 3CP1120-1140, 3CP1221-1241, 5CP2120W/2150W, 5CP3120, 5CP6120-6190, 5CPQ6221/6251
120220	STCP	7CP6170

* See Tech Bulletin 128

**Nylon protectors w/ two stainless screws.



OIL CAP PROTECTORS

Oil fill cap protector prevents water from entering crankcase. Not included with pump except on 4DX, 35 and 38 series pumps.

127409	PE	3CP, 5CP and 66DX Series
549726	PE	4DNX and 4DX Series
828710	PE	All piston and plunger pumps except the 1CX, 2SF, 2SFX, 3CP, 4DX, 4DNX, 4SF, 4SP, 4SPX, 5CP, 5SP, 66DX, 67DX

Material codes: AL = Aluminum, NY = Nylon, PE = Polyethylene, STCP = Steel/Chrome Plated

Pump Accessories



Keys – Direct Drive

Provides alignment and secures pump shaft to motor shaft or hub/pulley.

- Keys supplied with Cat Pumps.
- Keys supplied with gearboxes and flexible couplings.

PART NUMBER	SIZE (mm) UNLESS AS NOTED	PUMP MODELS
30050	3/16" x 3/16" x 1-1/4"	2SF Electric, Gas and Stainless Steel Series
30088	1/4" x 1/4" x 1-3/8"	Flexible Couplings: 8220, 8225, 8230
34050	3/16" x 3/16" x 27mm	4DNX25GSI/27GSI, 4DX Series, 4SP Series
44294	3/16" x 3/16" x 1-3/4"	Gearboxes (engine side): 8010, 8075
44459	8 x 7 x 24mm	Gearboxes (pump side): 8071, 8081
45217	1/4" x 1/4" x 64mm	66DX30G11/35G11/40G11
57352	5 x 5 x 21mm	Gearboxes (pump side): 8010, 8075
101814	6 x 6 x 27mm	Gearboxes (pump side): 8065, 8068, 8076, 8077
134760	1/4" x 1/4" x 45mm	5SP Series
831844	1/4" x 1/4" x 56mm	4SPX32G11

Keys – Belt Drive

Provides alignment and secures pump shaft to hub/pulley.

- Keys not supplied with pump.

PART NUMBER	SIZE (mm) UNLESS AS NOTED	PUMP MODELS
30047	5 x 5 x 24	280, 290, 333, 430, 230-277, 3CP1120 - 1140, 1221 - 1241
30057	6 x 6 x 25 (round end)	323, 390, 45, 310 - 350S, 311 - 357, 5CP2120W - 2150W, 5CP3120/3120CSS, 5CP5120 - 5140CSS, 5CP6120 - 6190, 5CPQ6221 - 6251 and Clutch models: 34962/63, 34970/80
30067	8 x 7.25 x 25	56, 530, 550, 700, 740, 760, 781/K, 784, 786, 650 - 661D, 1050 - 1057, 1530/31, 1540E/41, 1810/K, 7CP6110CS - 7CP6171CS
30089	5 x 5 x 36.5	Clutch models: 34960/961, 34964/965
34021	10 x 8 x 70	3501/C, 3507/C, 3511/C, 3517/C, 3520/C, 3521DHS/C, 3527, 3531D/C, 3535/C, 3537, 3541D/C, 3545, 3550, 3560, 3570, 3801-3841K
35034	6 x 8 x 26 (Step)	Clutch model: 34299
43048	14 x 9 x 90	6020, 6040, 6747, 6760-6775, 6801 - 6861K, 67070, 67102/C
50146	7 x 7 x 40	621, 623, 820, 821, 1010, 1011, 1951
890601	28 x 170 (Step)	152R060/C, 152R080/C, 152R100/C, 157R060, 157R080
890602	28 x 16 x 170	152R060/C, 152R080/C, 152R100/C, 157R060, 157R080
990036	8 x 7 x 40	1530/31, 1540E/41, 1560, 1570, 1580, 2510/11, 2520/C, 2530-2537, 2831/K
990069	8 x 6.35 x 40	Clutch model: 34563
991036	8 x 7 x 36	Clutch model: 34628

Rail, Direct Mount and Complete Mounting Assemblies

Mount pump onto a secure, horizontal base with either rail assemblies or direct mount assemblies.

- Rail assembly, direct mount assembly or complete mounting assembly not included with pump unless otherwise noted.
- Use direct mount assembly when mounting block or flat base is used or pulley extends over edge of base.



PART NUMBER	PUMP MODELS
RAIL ASSEMBLIES - STEEL/ZINC PLATED	
126604	6020, 6040, 6747, 6760 - 6775, 6801/K, 6811/K, 6821/K, 6831/K, 6841/K, 6861/K Included with pump
30611	333, 430, 323, 390, 310 - 350S, 311 - 357, 530, 550, 700, 740, 760, 781/K, 784, 786, 31, 45, 60, 5CP2120W-2150W, 5CP3120/3120CSS, 5CP5120-5140CSS, 5CP6120 - 6190, 5CPQ6221 - 6251
30612	280, 290, 230-277, 3CP1120-1140, 3CP1221-1241, 3CP1211CS
30613	623-1010, 650-661D, 1050-1057, 1530/31, 1540E/41, 1560, 1570, 1580, 1810/K, 7CP6110CS - 6171CS
30614	2520/2520C, 2510/11, 2530-2537, 2831/K
30637	5CP2120W-2150W, 5CP3120/3120CSS, 5CP5120 - 5140CSS, 5CP6120 - 6190, 5CPQ6221 - 6251 (Retrofit to GP/IP)
30645	530, 550, 45, 56, 60, 700, 740, 760, 781/K, 784, 786
76513	310-350S, 311-357, 530, 550, 56, 60, 5CP2120W - 2150W, 5CP3120/3120CSS, 5CP5120 - 5140CSS, 5CP6120 - 6190, 5CPQ6221 - 6251
92674	3501/C, 3507/C, 3511/C, 3517/C, 3520/C, 3521DHS/C, 3527, 3531D/C, 3535/C, 3537, 3541DK, 3520, 3545, 3550, 3560, 3570, 3801/K, 3811/K, 3821HS/KHS, 3831/K, 3841/K
990550	650 - 661D, 1050 - 1057 For Diesel or Gas mounts

DIRECT MOUNT ASSEMBLIES - STEEL/ZINC PLATED	
30243	333, 430, 323, 390, 310 - 350S, 311 - 357, 530, 550, 700, 740, 760, 781/K, 784, 786, 45, 56, 60, 5CP2120W - 2150W, 5CP3120/3120CSS, 5CP5120 - 5140CSS, 5CP6120 - 6190, 5CPQ6221 - 6251
30264	623 - 1010, 650 - 661D, 1050 - 1057, 1530/31, 1540E/41, 1560, 1570, 1580, 1810/K, 7CP6110CS - 6171CS
34018	3520/C, 3535, 3545, 3560
34039*	3501/C, 3507/C, 3511/C, 3517/C, 3521DHS/C, 3527, 3531D/C, 3537, 3541D/C, 3801/K, 3811/K, 3821HS/KHS, 3831/K, 3841/K

Note: * 304 stainless steel

MOUNTING ASSEMBLIES (Includes: rails, key, pulley/hub and shaft protector)	
30641	3CP1120-1140, 3CP1221-1241
30651	280, 290, 230-277
30652	333, 430
30653	623-1010
30659	323, 390, 310-350S, 311-357, 5CP2120W-5CP2150W, 5CP3120/CSS, 5CP5120-5CP5140CSS, 5CP6120-5CP6190, 5CPQ6221-6251
30660	530, 550, 700, 740, 760, 781/K, 784, 786, 56, 60
30661	650-661D, 1050-1057, 1530/31, 1540E/41, 1560, 1810/K

Drive Accessories

Bell Housing and Flexible Coupling

Compact direct mounting to hydraulic or electric motors reducing space requirements.

- Coupling assembly includes metric and standard coupling halves, spyder and keys.
- Special urethane flexible spyder designed for extended life with high temperature and high rpm
- Used with standard electric NEMA motors or SAEA2, SAEB2, SAEB4, SAEC2 and SAEC4 hydraulic motors

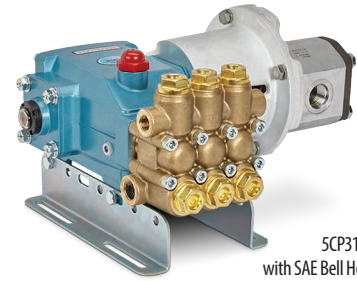

5CP3120CSS
with SAE Bell Housing
and Motor

Bell Housing Assembly, NEMA and SAE



76000 Series

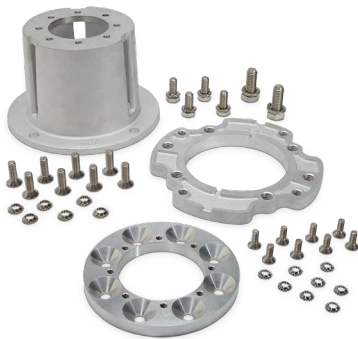

76SAEB4.7CP

PUMP SERIES	MODELS	ELECTRIC MOTOR		HYDRAULIC MOTOR	
		MOTOR FRAME	BELL HOUSING ASSY	SAE TYPE*	BELL HOUSING ASSEMBLY
3CP Series	All 3CP Models	56C - 145TC	76056.3CP	A2	76SAEA2.3CP
		182/184TC	76184.3CP	B2	76SAEB2.3CP
		213/215TC	76215.3CP	B4	76SAEB4.3CP
3FR Series	230 - 270, 231, 241, 271, 237, 247	56C - 145TC	76056.3FR	A2	76SAEA2.3FR
		182/184TC	76184.3FR	B2	76SAEB2.3FR
		213/215TC	76215.3FR	B4	76SAEB4.3FR
5CP Series	All 5CP Models	56C - 145TC	76056.5CP	A2	76SAEA2.5CP
		182/184TC	76184.5CP	B2	76SAEB2.5CP
		213/215TC	76215.5CP	B4	76SAEB4.5CP
5FR Series	340, 350, 341, 351, 347, 357	56C - 145TC	76056.5FR	A2	76SAEA2.5FR
		182/184TC	76184.5FR	B2	76SAEB2.5FR
		213/215TC	76215.5FR	B4	76SAEB4.5FR
7CP Series	All 7CP Models	182/184TC	76184.7CP	A2	76SAEA2.7CP
		213/215TC	76215.7CP	B2	76SAEB2.7CP
		254/256TC	76256.7CP	B4	76SAEB4.7CP
7FR/8FR Series	56-60, 700-760, 781-786	182/184TC	76184.7FR	A2	76SAEA2.7FR
		213/215TC	76215.7FR	B2	76SAEB2.7FR
		254/256TC	76256.7FR	B4	76SAEB4.7FR
15FR Series	All 15FR Models	213/215TC	76215.15FR	B2	76SAEB2.15FR
		254/256TC	76256.15FR	B4	76SAEB4.15FR
		284/286TC	76286.15FR		
35FR Series	All 35FR Models			C2/C4	76SAEC.35FR

Bell housing assemblies include mounting hardware and flange

*SAE Type: A2 = SAE "A" 2 Bolt, 3.25" Pilot, B2 = SAE "B" 2 Bolt, 4" Pilot, B4 = SAE "B" 4 Bolt, 4" Pilot, C2 = SAE "C" 2 Bolt, 5" Pilot, C4 = SAE "C" 4 Bolt, 5" Pilot

IEC Bell housing available upon request.

Need selection help?

Q. How can I find the rpm needed to get specific gpm (Gallons Per Minute) I want?

A. Desired rpm = $\frac{\text{Rated rpm}}{\text{Desired gpm} \times \frac{\text{Rated gpm}}{\text{Rated rpm}}}$

Q. I have to run my pump at a certain rpm. How do I figure the gpm I'll get?

A. Desired gpm = $\frac{\text{Rated gpm}}{\text{Desired rpm} \times \frac{\text{Rated rpm}}{\text{Rated gpm}}}$

Q. Is there a simple way to find the approximate horsepower I'll need to run the pump?

A. Electric Brake Horsepower (Standard 85% Mech. Efficiency)

Required hp* = $\frac{\text{gpm} \times \text{psi}}{1460}$

Q. What size motor pulley should I use?

A. Pump Pulley (Outer Diameter) x

$\frac{\text{Pump rpm}}{\text{Motor/Engine rpm}}$

*Consult Engine Manufacturer

Flexible Coupler Assemblies

PUMP SERIES	MOTOR FRAME	FLEX COUPLER ASSY	TORQUE RATING	SAE TYPE*	FLEX COUPLER ASSY	SHAFT TO SHAFT	TORQUE RATING
3CP & 3FR	56C	8215	27 ft/lbs	A2	8271	16.5 mm x 5/8"	115 ft/lbs
	145TC	8210	27 ft/lbs	B2	8272	16.5 mm x 7/8"	115 ft/lbs
	182/184TC	8220	27 ft/lbs	B4	8272	16.5 mm x 7/8"	115 ft/lbs
	182/184TC	8225	74 ft/lbs				
	213/215TC	8270	92 ft/lbs				
5CP & 5FR	56C	8261	74 ft/lbs	A2	8273	20 mm x 5/8"	115 ft/lbs
	145TC	8260	74 ft/lbs	B2	8274	20 mm x 7/8"	115 ft/lbs
	182/184TC	8230	74 ft/lbs	B4	8274	20 mm x 7/8"	115 ft/lbs
	213/215TC	8275	92 ft/lbs				
	254/256TC	8217	150 ft/lbs				
7CP & 7FR	56C	8218	74 ft/lbs				
	182/184TC	8370	74 ft/lbs	A2	8371	24 mm x 5/8"	145 ft/lbs
	213/215TC	8375	74 ft/lbs	B2	8372	24 mm x 7/8"	145 ft/lbs
	254/256TC	8380	150 ft/lbs	B4	8372	24 mm x 7/8"	145 ft/lbs
15FR	213/215TC	8388	150 ft/lbs	B2/B4	8387	30mm x 7/8"	92 ft/lbs
	254/256TC	8382	150 ft/lbs				
	284/286TC	8383	225 ft/lbs				
35FR				C2/C4	997872	35mm x 1 1/4"	350 ft/lbs
				C2/C4	999368	35mm x 1 3/8"	350 ft/lbs
				C2/C4	994403	35mm x 1 1/2"	350 ft/lbs
				C2/C4	999180	35mm x 1 5/8"	350 ft/lbs
				C2/C4	999206	35mm x 1 7/8"	350 ft/lbs

*SAE Type: A2 = SAE "A" 2 Bolt, 3.25" Pilot, B2 = SAE "B" 2 Bolt, 4" Pilot, B4 = SAE "B" 4 Bolt, 4" Pilot, C2 = SAE "C" 2 Bolt, 5" Pilot, C4 = SAE "C" 4 Bolt, 5" Pilot

IEC Flexible Coupler Assemblies available upon request.



Hubs and Hub/Key Assemblies

Metric sized hubs to match metric shaft diameter of pump.

- Contact Cat Pumps for available hubs for motor shafts.
- Metric sized hub with matching metric key for pump shaft only.

PUMP SHAFT DIAMETER (mm)	TYPE	PART NUMBER	PUMP MODELS
HUB (steel)			
16.5	H	30943 *	230-277, 280, 290, 333, 430, 3CP1120-140, 3CP1221-1241
20	H	30945 *	310-350S, 323, 390, 311-357, 45, 5CP2120W-2150W, 5CP3120/3120CSS, 5CP5120-5140CSS, 5CP6120-6190, 5CPQ6221-6251
24	H	33000 *	530, 550, 700, 740, 760, 781/K, 784, 786, 56, 60, 7CP6110CS-7CP6171CS
25	H	30234	621, 623, 820, 821, 1010, 1011
30	B	990012 *	650-661D, 1050-1057, 1530/31, 1540E/41, 1560, 1570, 1580, 1810/K, 2510/11,
30	H	30059 *	2530-2537, 2831/K
35	B	990013 *	3501/C, 3507/C, 3511/C, 3517/C, 3520/C, 3521DHS/D/C, 3527, 3531D/C, 3535/C, 3537, 3541D/C, 3545, 3550, 3560, 3570, 3801/K, 3811/K, 3821HS/KHS, 3831/K, 3841/K
45	B	990014 *	6020, 6040, 6747, 6760-6775, 6801/K, 6811/K, 6821/K, 6831/K, 6841/K, 6861/K
100	M	990068	152R060/C, 152R080/C, 152R100/C, 157R060, 157R080

Note: *Add "Z" to part number for zinc plated hub

HUB AND KEY ASSEMBLY (steel)			
16.5	H	30942	280, 290, 333, 430, 3CP1120-1140, 3CP1221-1241, 230-277
20	H	30944	323, 390, 310-350S, 311-357, 45, 5CP2120W-2150W, 5CP3120/3120CSS, 5CP5120-5140CSS, 5CP6120-6190, 5CPQ6221-6251
25	H	30284	621, 623, 820, 821, 1010, 1011
30	H	30209	2510/11, 2520/C, 2530-2537, 2831/K



Drive Accessories



Clutches

Engages/disengages pump and drive device to meet flow demands.

- Reduces amount of time pump is running, saving energy and increasing pump life.
- Broad range of clutches up to 100 ft-lbs torque for high performance.

MODELS	CLUTCH DIAMETER/ NUMBER OF GROOVES	BELT TYPE	PUMP SHAFT DIAMETER	PUMP MODELS
34960	7" / 1	A	16.5 mm	3CP1120 - 1140, 3CP1221 - 1241
34961	7" / 1	A	16.5 mm	280, 290, 333, 430, 230 - 277
34962	7" / 1	A	20.0 mm	323, 390, 310 - 350S, 311 - 357, 45
34963	7" / 2	A	20.0 mm	323, 390, 310 - 350S, 311 - 357, 45
34964	7" / 2	A	16.5 mm	280, 290, 333, 430, 230 - 277
34965	7" / 2	A	16.5 mm	3CP1120 - 1140, 3CP1221 - 1241
34970	7" / 1	A	20.0 mm	
34980	7" / 2	A	20.0 mm	5CP2120W - 2150W, 3120/3120CSS, 5120 - 5140CSS, 5CP6120 - 6190, 5CPQ6221 - 6251
34299	7.3" / 8	Poly-V, L-Style	20.0 mm	
34959	7.3" / 8	Poly-V, L-Style	24.0 mm	56, 60, 530, 550, 700, 740, 760, 781/K, 784, 786
34971	7.3" / 8	Poly-V, L-Style	24.0 mm	7CP6110CS - 7CP6171CS
76970	10" / 2	B	20.0 mm	5CP Plunger Pumps
76980	10" / 2	B	20.0 mm	323, 390, 310 - 350S, 311 - 357, 45
34628	12.4" / 1	B	24.0 mm	56, 60, 530, 550, 700, 740, 760, 781/K, 784, 786
34630	12.4" / 2	B	24.0 mm	56, 60, 530, 550, 700, 740, 760, 781/K, 784, 786
34563	12.4" / 2	B	30.0 mm	650 - 661D, 1050 - 1057, 1530/31, 1540E/41, 1560, 1570, 1580, 1810/K
30655	12.4" / 2	B	30.0 mm	2510, 2511, 2530, 2530E, 2531, 2537, 2831



Pulleys and Pulley/Hub w/Key

A combination one-piece pulley and hub construction for pump shaft installation.

- Contact Cat Pumps for available pulley sizes for either pump or motor side.

PUMP SHAFT DIAMETER (mm)	PART NUMBER	PULLEY DIAMETER NO. OF GROOVES	BELT TYPE	PUMP MODELS
PULLEY/HUB COMBINATION WITH TWO SET SCREWS (steel/zinc plated)				
16.5	30032	5" / 1	A	230, 290, 333, 430, 3CP Series
16.5	30048	8" / 1	A/B	230, 290, 333, 430, 3CP Series
20	30058	8" / 1	A/B	310 - 357, 5CP Series
PULLEY/HUB COMBINATION WITH TWO SET SCREWS AND KEY ASSEMBLY (steel)				
16.5	30244	8" / 1	A/B	230, 290, 333, 430, 3CP Series
16.5	30246	5" / 1	A	230, 290, 333, 430, 3CP Series
20	30633	8" / 1	A/B	310 - 357, 5CP Series
PULLEY ONLY (cast iron)				
HUB SIZE	PART NUMBER	PULLEY DIAMETER NO. OF GROOVES	BELT TYPE	PUMP MODELS
H	30206	10" / 2	A/B	530, 550, 623-1010, 700, 740, 760, 781/K, 784, 786, 650 - 661D, 1050-1057, 1530/31, 1540E/41, 1560, 1810/K, 2510/11, 2530-2537, 2831/K

Service Tools



Wrenches

Simplifies servicing the crankcase, plunger rod or manifold.

- T-Wrenches used for servicing crankcase or plunger.
- L-Wrenches used for servicing valves.
- Allen wrenches used for serving SF, SP, SPX, CP, DX, DNX series manifolds.

T-WRENCHES

MODEL	25052	25082	44044	25324	25053
SIZE	M8	M10	M11	M13	M14

L-WRENCHES

MODEL	44046	44045
SIZE	M24	M27

ALLEN WRENCHES

MODEL	30941	33046	33047	33048	33049	34113	34030
SIZE	M6	M8	M10	M12	M14	7/64"	5/32"



Pliers

Quick valve and snap ring removal/installation.

- Reverse pliers used for easy valve seat removal.
- Snap ring pliers used for Inlet Stabilizers assemblies.

REVERSE PLIERS

MODEL	30696
--------------	-------

SNAP RING

MODEL	33285
--------------	-------



Oil Gauge Removal Tool

Quick and easy replacement of crankcase oil gauge.

- Required for replacement of oil gauge.

MODEL	44050
SIZE	M28

Service Tools

Seal Case Removal Tools

Simplifies seal replacement for various plunger pumps.

- Available as 1/2" socket or T-wrench.

1/2" DRIVE SOCKETS

MODEL	33004	33005	33006
FRAME	5 Frame	7 Frame	15 Frame

T-WRENCHES

MODEL	45103	43257	43523
FRAME	5 Frame	7 Frame	15 Frame



Piston Pump Tools

These specialty installation tools minimize risk of damage to cup/seal during replacement.

- Used for piston pumps only.

CUP INSTALLATION

MODEL	16981	22130	43548	43749	27964	15770	27853
MODELS USED	280, 290, 820	280, 290, 430, 623	320, 323	333	390	1010	2520

SEAL INSTALLATION

MODEL	25084
FRAME	3, 4 Frame



Seal Tool
25084



Cup Tool
15770

Crankcase Oil Seal Kit

This specialty oil seal tool kit will assist in replacement of the 60 frame crankcase oil seals.

- Remove and re-install crankcase oil seal from wet-end.
- Minimize risk of damage to plunger/piston rod surfaces.
- Used for plunger or piston pumps

MODEL	31173
INCLUDES	Guide, washer, 9 screws and 3 oil seals



Demand Genuine Cat Pumps Accessories



Maximum System Performance

Cat Pumps offers a wide range of high quality accessories adhering to the same exacting standards as our industry-leading pumps. Every accessory is performance tested and designed to match each pump's operating specifications. By demanding genuine Cat Pumps products, you receive the best value and lowest cost of ownership over the life of the system. Protect your pumping system investment with the brand you can trust — Cat Pumps.

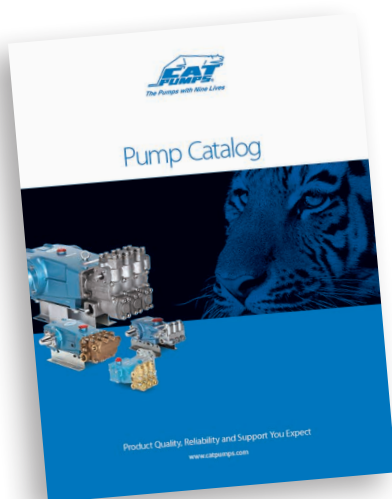

Check out our complete product line of pumps, accessories and pumping systems online at catpumps.com



Cat Pumps occupies over 145,000 sq. ft. at its world headquarters in Minneapolis, MN.

Cat Pumps Locations

Cat Pumps – World Headquarters

1681 94th Lane Northeast
Minneapolis, MN 55449
USA

P: (763) 780-5440
F: (763) 780-2958
techsupport@catpumps.com
www.catpumps.com

Territories Served

U.S., Canada

International Division

P: (763) 780-5440
F: (763) 785-4329
intlsales@catpumps.com
www.catpumps.com

Territories Served

Africa, Asia, Australia, Central and South America, Mexico, Middle East, New Zealand, Turkey

Cat Pumps International N.V.

Heiveldekens 6A
2550 Kontich
Belgium

P: 32 3 450 71 50
F: 32 3 450 71 51
cpi@catpumps.be
www.catpumps.be

Territories Served

Western Europe (except U.K., Germany, and Austria)

Cat Pumps (U.K.) Ltd.

1 Fleet Business Park, Sandy Lane
Church Crookham
FLEET, Hampshire GU52 8BF
England

P: +44 1252 622031
F: +44 1252 626655
sales@catpumps.co.uk
technical@catpumps.co.uk
www.catpumps.co.uk

Territories Served

U.K. and Ireland

Cat Pumps Deutschland GmbH

Buchwiesse 2, D-65510
Idstein
Germany

P: +49 6126 9303 0
F: +49 6126 9303 33
catpumps@t-online.de
www.catpumps.de

Territories Served

Austria, Commonwealth of Independent States (CIS), Germany and Eastern Europe

SALES, DISTRIBUTION, SERVICE Call today for product and application assistance. (763) 780-5440 or visit us at www.catpumps.com



CAT PUMPS

1681 - 94TH LANE N.E. MINNEAPOLIS, MN 55449-4324
PHONE (763) 780-5440 — FAX (763) 780-2958
e-mail: info@catpumps.com
www.Catpumps.com

For International inquiries go to www.catpumps.com and navigate to the "Contact Us" link.

©2018 Cat Pumps Inc. All rights reserved. All written and visual data contained in this document are based on the latest product information available at the time of publication. Cat Pumps reserves the right to make changes at any time without notice. All other brand names or marks are used for identification purposes and are trademarks of their respective owners.