

# DATA SHEET

## 5FR PISTON PUMPS

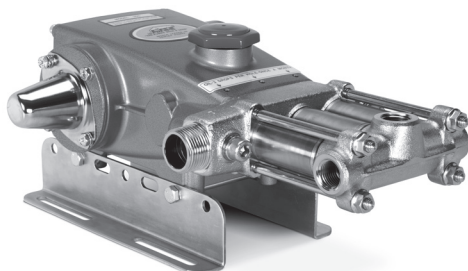

### Brass Models: 323, 390



Model 390 Shown  
(Shaft protector and mounting rails sold separately)

#### FEATURES

- Triplex Uniflow design provides continuous forward liquid, promoting smooth operation.
- Wetted cups and floating pistons are lubricated and cooled by pumped liquids, promoting cup life.
- Mechanically-actuated inlet valves create strong lift and easier prime.
- Pump comes standard with NBR seals. Alternative seal materials are available for higher temperature or chemical compatibility.

#### COMMON SPECIFICATIONS

	U.S.	Metric
Crankcase Capacity	21 oz	0.62 l
Discharge Ports (3)	½" NPT(F)	½" NPT(F)
Pulley Mounting	Either Side	Either Side
Shaft Diameter	0.787"	20 mm

#### SPECIFICATIONS

#### U.S. Measure

#### Metric Measure

##### Models 323

Flow	5.0 gpm	19 lpm
Pressure Range	100–1500 psi	6.9–103 bar
Inlet Pressure Range	-8.5 to 40 psi	-0.6 to 2.8 bar
Max. Liquid Temperature (NBR)	160° F	71° C

##### Alternative seals available for higher temperatures up to 180° F

Pump RPM*	1000 rpm	1000 rpm
Bore	0.866"	22 mm
Stroke	0.669"	17 mm
Inlet Port (1)	½" NPT(F)	½" NPT(F)
Auxiliary Port (1)	¼" NPT(F)	¼" NPT(F)
Weight	16.6 lbs	7.5 kg
Dimensions	12.4 x 10.0 x 5.28"	315 x 254 x 134 mm

##### Models 390

Flow	12.0 gpm	45.4 lpm
Pressure Range	100–600 psi	6.9–41 bar
Inlet Pressure Range (up to 8 gpm)	-8.5 to 40 psi	-0.6 to 2.8 bar
Inlet Pressure Range (8 to 12 gpm)	Flooded to 40 psi	Flooded to 2.8 bar
Max. Liquid Temperature (NBR)	140° F	60° C

##### Alternative seals available for higher temperatures up to 180° F

Pump RPM*	1200 rpm	1200 rpm
Bore	1.260"	32 mm
Stroke	0.629"	16 mm
Inlet Port (1)	1" NPT(M)	1" NPT(M)
Weight	18.8 lbs	8.5 kg
Dimensions	14.3 x 10.0 x 5.28"	363 x 254 x 134 mm

\*Pump minimum is 100 rpm

#### ALTERNATIVE SEAL CONFIGURATION

MATERIAL	SUFFIX CODE	MAXIMUM TEMPERATURE	
NBR	—	160° F	(71° C)
FPM	.0110	180° F	(82° C)
HT	.3000	180° F	(82° C)

See **Tech Bulletin 002** for inlet conditions and RPM at high-temperature.

#### DETERMINING THE PUMP RPM

$$\frac{\text{Rated gpm}}{\text{Rated rpm}} = \frac{\text{Desired gpm}}{\text{Desired rpm}}$$

#### DETERMINING THE REQUIRED HP

$$\frac{\text{hp}}{\text{(Electric Brake)}} = \frac{\text{gpm} \times \text{psi}}{1460}$$

#### DETERMINING MOTOR PULLEY SIZE

$$\frac{\text{Motor Pulley OD}}{\text{Pump rpm}} = \frac{\text{Pump Pulley OD}}{\text{Motor rpm}}$$

Refer to pump **Service Manual** for repair procedure and additional technical information.

## PARTS LIST

ITEM	PART NUMBER		DESCRIPTION		QTY	
	323	MATL	390	MATL		
5	125824	STCP R	125824	STCP R	Screw, HHC Sems (M6 x 16) (See Tech Bulletin 074)	8
8	43344	AL	43344	AL	Cover, Bearing	2
10	43343	NBR	43343	NBR	O-Ring, Bearing Cover-70D	2
11	43222	NBR	43222	NBR	Seal, Oil	2
15	14480	STL R	14480	STL R	Bearing, Ball	2
20	45883	HS	45883	HS	Assembly, Connecting Rod (See Tech Bulletin 074)	3
25	43342	FCM	43342	FCM	Crankshaft	1
32	43211	ABS	43211	ABS	Cap, Oil Filler	1
33	14177	NBR	14177	NBR	O-Ring, Oil Filler Cap-70D	1
37	92241	PC	92241	PC	Gauge, Oil Bubble with Gasket-80D (See Tech Bulletin 074)	1
38	44428	NBR	44428	NBR	Gasket, Flat, Oil Gauge-80D	1
40	126541	STCP R	126541	STCP R	Screw, HHC Sems (M6 x 20) (See Tech Bulletin 074)	4
48	25625	STCP	25625	STCP	Plug, Drain (1/4" x 19 BSP)	1
49	23170	NBR	23170	NBR	O-Ring, Drain Plug-70D	1
50	48772	AL	48772	AL	Cover, Rear (See Tech Bulletin 090)	1
51	48773	NBR	48773	NBR	O-Ring, Cover (See Tech Bulletin 090)	1
53	48769	AL	48769	AL	Crankcase (See Tech Bulletin 090)	1
54	126231	STCP R	126231	STCP R	Lockwasher (M10)	2
55	<b>126531</b>	STCP R	<b>126516</b>	STCP R	Screw (323: M10 x 30) (390: M10 x 50)	2
56	43355	POP	43355	POP	Pan, Oil	1
64	43351	CM	43351	CM	Pin, Crosshead	3
65	<b>43775</b>	SZZ	<b>44312</b>	SZZ	Rod, Piston	3
70	43527	NBR	43527	NBR	Seal, Oil	3
75	25327	S	25327	S	Slinger, Barrier	3
77	25392	NBR	25392	NBR	O-Ring, Sleeve-70D	6/3
80	<b>25299</b>	SCP	<b>44311</b>	SCP	Sleeve	3
	<b>28460</b>	S	—	—	<i>Sleeve Unchromed (323)</i>	3
81	<b>29003</b>	PTFE	—	—	Backup Ring, Sleeve	3/0
100	43530	PVDF	43530	PVDF	Retainer, Seal	3
101	43532	—	43532	—	Wick, Long Tab	3
106	<b>25153</b>	NBR	—	—	Seal, LPS, Blue Dot	3
	—	—	<b>100015</b>	FPM	Seal, LPS, (Ungreased)	3
110	<b>43767</b>	BBCP	<b>44286</b>	BBCP	Manifold, Inlet (323: Bottom Port) (390: Side Port)	1
112	—	—	<b>43781</b>	NBR	O-Ring, Adapter, Inner-75D	0/3
113	—	—	<b>11261</b>	FBR	Spacer, Cylinder (Center Only)	0/1
114	—	—	<b>44287</b>	BB	Adapter, Inlet	0/3
116	—	—	<b>27536</b>	NBR	O-Ring, Inlet Adapter, Outer-70D	0/6
119	<b>43533</b>	S	<b>27944</b>	S	Valve, Inlet	3
130	—	—	<b>27945</b>	S	Piston	3
133	<b>129579</b>	NBR	<b>27946</b>	FPM	Cup, Piston (323: Machined)	3
135	<b>27983</b>	S	<b>27796</b>	S	Spacer, Piston	3
136	<b>29588</b>	S	<b>27947</b>	S	Retainer, Piston	3
137	<b>27006</b>	S	<b>15850</b>	S	Washer	3
138	<b>27000</b>	S	<b>26546</b>	S	Nut, Slotted	3
139	14158	S	14158	S	Cotterpin (M1.6 x 10)	3
143	<b>43781</b>	NBR	—	—	O-Ring, Cylinder-75D	3
150	<b>43768</b>	SCP	<b>44288</b>	SCP	Cylinder	3
	<b>43835</b>	S	—	—	<i>Cylinder Unchromed (323)</i>	3
153	<b>21986</b>	PTFE	—	—	Backup Ring, Cylinder	3
155	—	—	<b>27536</b>	NBR	O-Ring, Adapter, Inner-70D	0/3
157	—	—	<b>44310</b>	BB	Adapter, Discharge	0/3
159	43781	NBR	43781	NBR	O-Ring (323: Cylinder-75D) (390: Adapter-75D)	3
163	43793	NBR	43793	NBR	O-Ring, Seat-90D	3
164	<b>43779</b>	S	<b>103956</b>	S	Seat	3
166	<b>43721</b>	S	<b>104302</b>	S	Valve	3
167	43251	S	43251	S	Spring	3
168	<b>43780</b>	S	<b>103957</b>	S	Retainer, Spring	3
185	43770	BBCP	43770	BBCP	Manifold, Discharge	1
187	<b>126782</b>	STCP R	<b>126551</b>	STCP R	Stud, Discharge Manifold (323: M8 x 100) 390: [M8 x 110])	4
194	126201	STCP R	126201	STCP R	Nut, Hex Flange (See Tech Bulletin 074)	4

**Bold print part numbers are unique to a particular pump model.** *Italics are optional items.* [ ] Date of latest production change.

R Components comply with RoHS Directive. For additional technical information see [www.catpumps.com/literature/tech-bulletins](http://www.catpumps.com/literature/tech-bulletins).

MATERIAL CODES (Not Part of Part Number): ABS=ABS Plastic AL=Aluminum BB=Brass BBCP=Brass/Chrome Plated CM=Chrome-Moly FBR=Fiber

FCM=Forged Chrome-moly FPM=Fluorocarbon HS=High Strength NBR=Medium Nitrile (Buna-N) NY=Nylon PC=Poly Carbonate POP=Polypropylene PTFE=Pure Polytetrafluoroethylene  
PVDF=Polyvinylidene Fluoride S=304SS SCP=304SS/Chrome Plated SNG=Special Blend (Buna) STL=Steel STCP=Steel/Chrome Plated STZP=Steel/Zinc Plated SZZ=304SS/Zamak

# EXPLODED VIEW

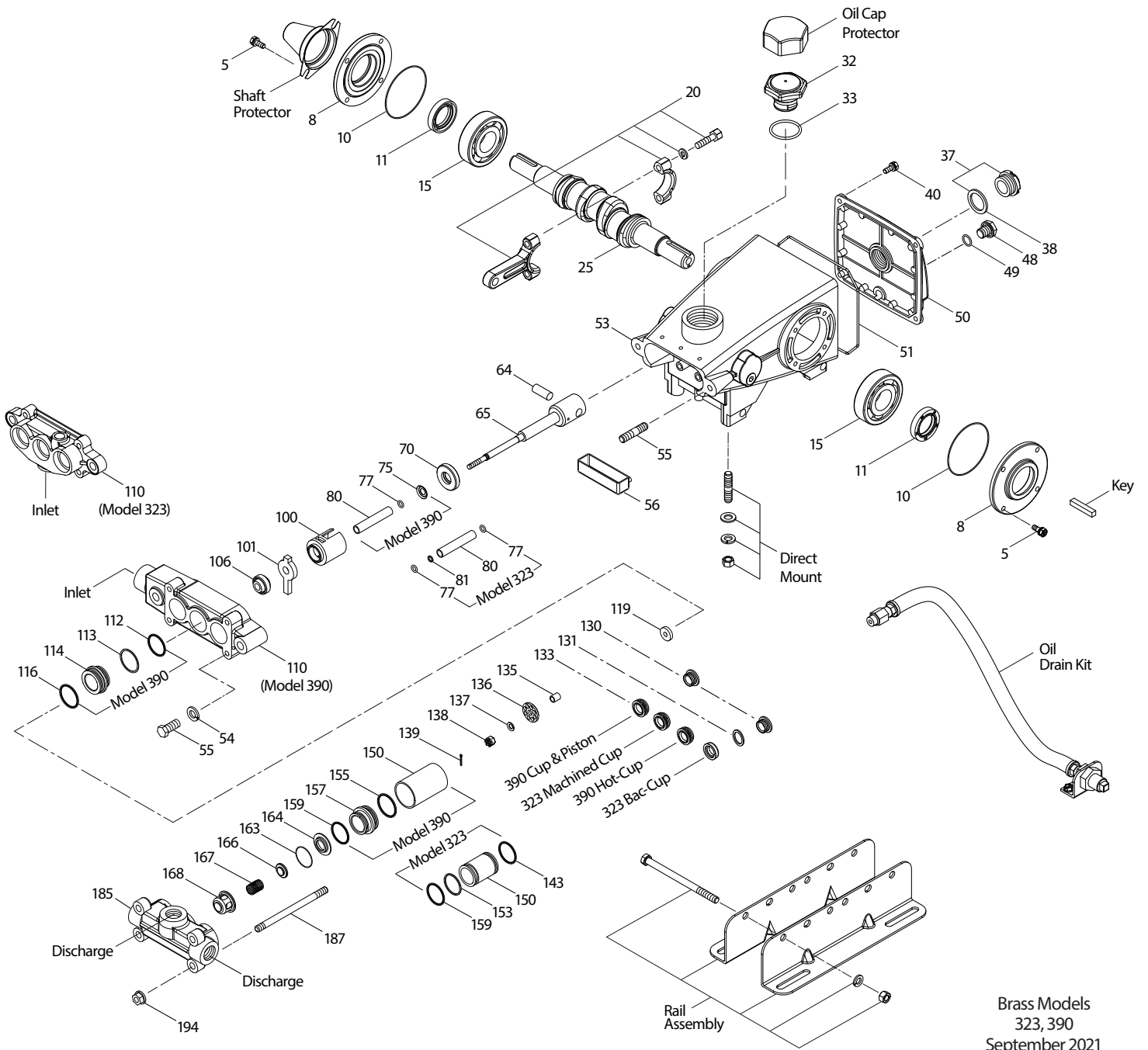

## OPTIONAL PARTS AND ACCESSORIES

PART	DESCRIPTION	QTY
30057	Key (M6 x 6 x 25)	1
30611	Assembly, Rail	1
30241	Assembly, Box Rail (Not Shown)	1
30243	Mount, Direct	1
828710	Protector, Oil Cap	1
118672	Protector, Shaft	1
34334	Kit, Oil Drain	1
30633	Pulley (30058) and Key (30057) Assembly	1
30944	Hub (30945) and Key (30057) Assembly	1

## SERVICE PARTS

PART	DESCRIPTION	QTY
<b>34011</b>	Kit, Seal – Blue Dot (Model 323)	1
<b>31825</b>	Kit, Seal – FPM (Model 390)	1
<b>30859</b>	Kit, Valve (Quiet) – NBR (Model 323)	1
<b>34010</b>	Kit, Valve (Flat) – NBR (Model 390)	1
6107	Oil, Bottle (21 oz) ISO 68 Hydraulic (Fill to Specified Crankcase Capacity Prior to Start-up)	2
6124	Gasket, Liquid (3 oz)	1

## SEAL KITS One (1) seal kit required per pump

PUMP MODELS	Blue Dot*	NBR	FPM
323	34011	30305	
390		30305	31825

ITEM (Included in Seal Kits)	DESCRIPTION			QTY
77		28771	O-Ring, Sleeve	3
101	43532	43532	Wick	3
106	25153*	30315***	100015** Seal, Low-Pressure	3
139	14158	14158	Cotterpin	3

\*Ungreased Seal, No Garter Spring

\*\* Ungreased Seal

\*\*\*Use PN 30325 for FPM (Greased Seal)

## SLEEVE AND SEAL KIT One (1) sleeve and seal kit required per pump

PUMP MODELS	NBR	NBR (STD)
323	30312	
390		31824

ITEM (Included in Sleeve and Seal Kits)	DESCRIPTION		QTY
75	25327	25327 Slinger, Barrier	3
77	25392*	25392* O-Ring, Sleeve	6/3
80	25299	44311 Sleeve	3
101		43532 Wick	3
106	30315***	100015** Seal, Low-Pressure	3
139	14158	14158 Cotterpin	3

\*Use PN 28771 for FPM

\*\*Ungreased Seal

\*\*\*Use PN 30325 for FPM (Greased Seal)

## CUP KITS One (1) cup kit required per pump

PUMP MODELS	323	323	390	390
	NBR (STD)	NBR (BAC)	FPM (.0110)	NBR (HOT)
	30993	30858	31822	

ITEM (Included in Cup Kits)	DESCRIPTION				QTY	
131					Ring, Bac-Cup	3
133	129579	43792**	27946	29093	Cup	3
139	14158	14158	14158		Cotterpin	3
143	43781*	43781*	43781*		O-Ring, Cylinder	6
155			27536		O-Ring, Discharge Adapter	6
355		43548	27964		Insertor, Cup	1

\*\* Use PN 11337 for FPM

\*\*Use PN 43789 for FPM BAC-CUP

## PISTON KITS One (1) piston kit required per pump

PUMP MODELS	323	323	390
	NBR (STD)	NBR (BAC)	NBR (STD)
	30992	30857	31823

ITEM (Included in Piston Kits)	DESCRIPTION			QTY	
112			43781*	O-Ring, Inlet Adapter	3
116			27536**	O-Ring, Inlet Adapter	3
119	43533	43533	27944	Valve, Inlet	3
130	22021	43787	27945	Piston	3
131		43788		BAC-Cup Ring	3
133	129579	43792	27946	Cup	3
135	27983	27983	27796	Spacer, Piston	3
136	29588	29588	27947	Retainer, Piston	3
137	27006	27006	15850	Washer	3
138	27000	27000	26546	Nut, Slotted	3
139	14158	14158	14158	Cotterpin	3
143	43781*	43781*		O-Ring, Cylinder	3
153	21986	21986		Backup Ring, Cylinder	3
155			27536**	O-Ring, Discharge Adapter	3
159	43781*	43781*	43781*	O-Ring, Cylinder Adapter	3
355			27964	Insertor, Cup	1

\*Use PN 11377 for FPM

\*\*Use PN 43174 for FPM

## VALVE KITS One (1) valve kit required per pump

PUMP MODELS	NBR (QUIET)	NBR (FLAT)
323, 390	30859	34010

ITEM (Included in Valve Kits)	DESCRIPTION		QTY	
155		27536***	O-Ring, Discharge Adapter	3
159	43781*	43781*	O-Ring, Cylinder, Adapter	3
163	43793**	43793**	O-Ring, Seat	3
164	43779	103956	Seat	3
166	43721	104302	Valve	3
167	43251	43251	Spring	3
168	43780	103957	Retainer, Spring	3

\* Use PN 11337 for FPM

\*\* Use PN 43791 for FPM

\*\*\*Use PN 43174 for FPM

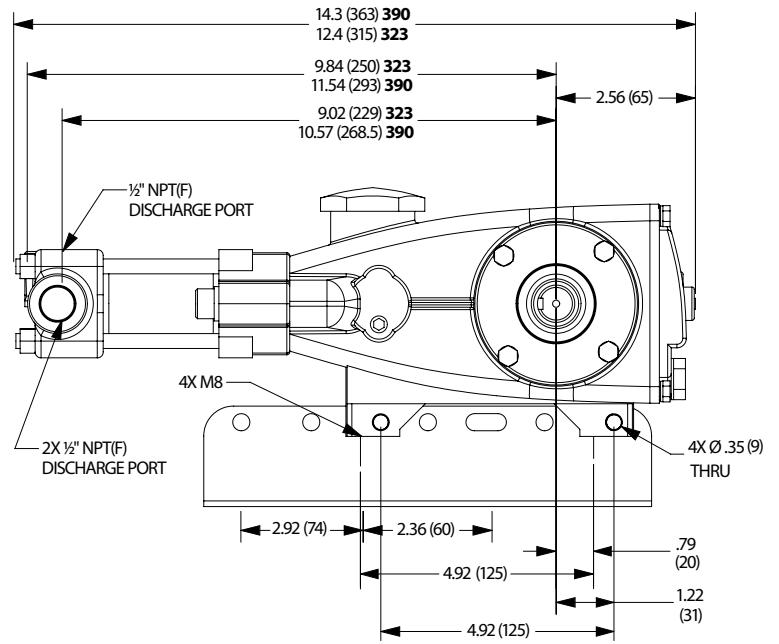
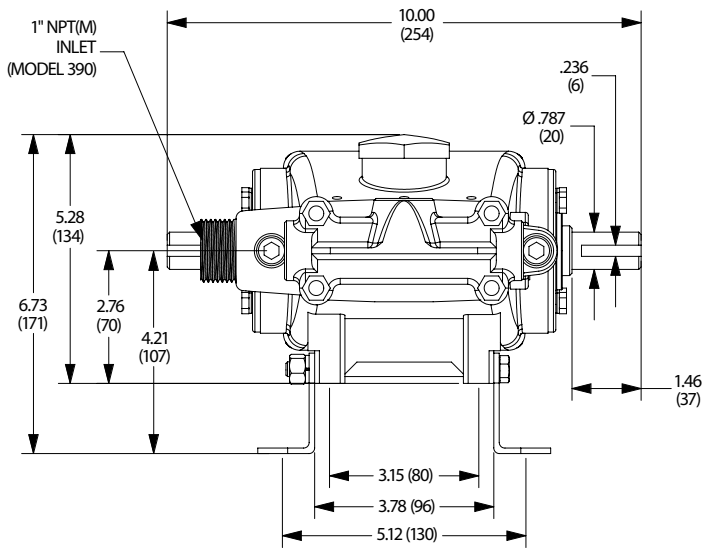

Models 323, 390

**CAUTIONS AND WARNINGS**

All high-pressure systems require a primary pressure regulating device (i.e. regulator, unloader) and a secondary pressure relief device (i.e. pop-off valve, relief valve). Failure to install such relief devices could result in personal injury or damage to pump or property. Cat Pumps does not assume any liability or responsibility for the operation of a customer's high-pressure system. Read all CAUTIONS and WARNINGS before commencing service or operation of any high-pressure system. The CAUTIONS and WARNINGS are included in each Service Manual and with each Accessory Data sheet. CAUTIONS and WARNINGS can also be viewed online at [www.catpumps.com/dynamic-literature/cautions-and-warnings](http://www.catpumps.com/dynamic-literature/cautions-and-warnings) or can be requested directly from Cat Pumps.

**WARRANTY**

View the Limited Warranty online at [www.catpumps.com/literature/cat-pumps-limited-warranty](http://www.catpumps.com/literature/cat-pumps-limited-warranty)

**CAT PUMPS** 1681 94th Lane N.E., Minneapolis, MN 55449-4324 P: (763) 780-5440 F: (763) 780-2958 E: [techsupport@catpumps.com](mailto:techsupport@catpumps.com) [www.catpumps.com](http://www.catpumps.com)

©2021 Cat Pumps Inc. All rights reserved. All data contained in this document are based on the latest product information available at the time of publication. Cat Pumps reserves the right to make changes at any time without notice.