

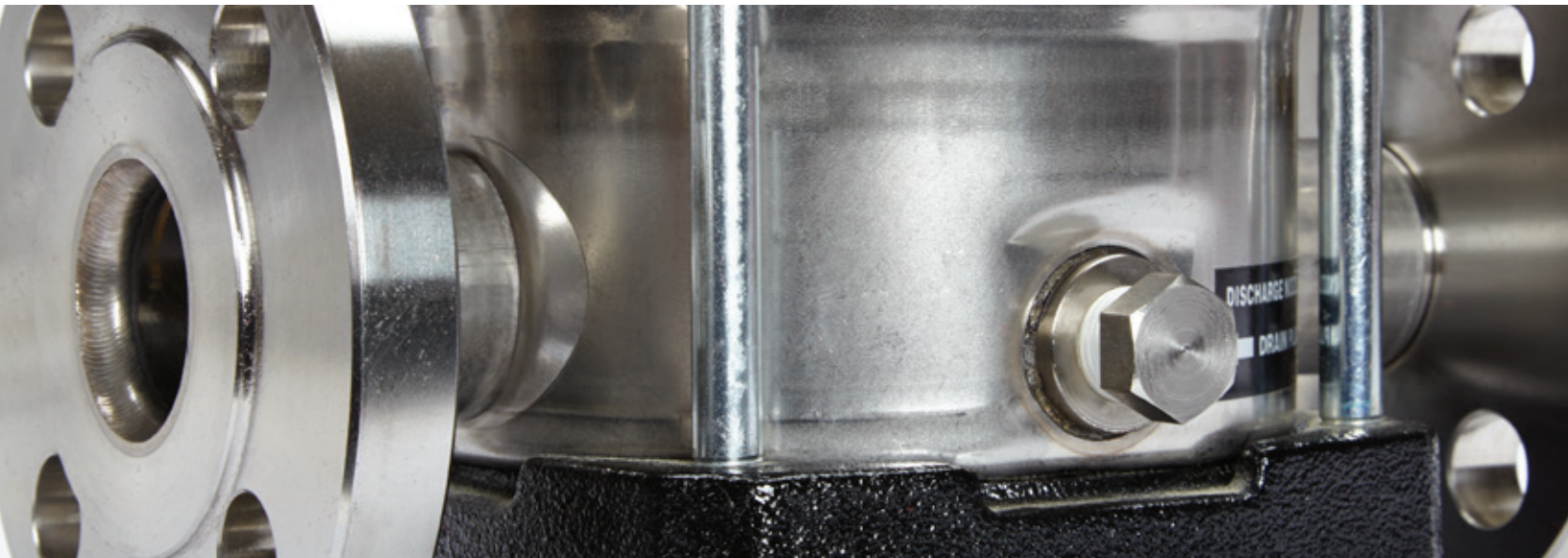

# 8K Series Pumps

Stainless Steel Multistage Centrifugal Pumps



Product Quality, Reliability and Support You Expect

[www.catpumps.com](http://www.catpumps.com)

# 8K Multistage Centrifugal Pumps

Designed for long-life and trouble free service, the 8K series are a superior line of multistage centrifugal pumps. Originally engineered for booster, water purification, and hot water applications, many other industries have adopted this product due to its reliable performance.

The 8K series are truly an industrial grade pump, consisting of 304 or 316 SS hydraulic assemblies constructed with cast stainless steel flanges for maximum installation support. Different mechanical seal face options are available and incorporate a separate thrust bearing in place of motor bearings, adding to the robust design of this product. The 8K also features tungsten carbide lower pump bearings and sleeves – standard construction for all services, providing maximum operating life. Count on the 8K to get the job done.



## Features:

- All stainless steel wetted parts (8K, 8KC feature 304SS – 8KS feature 316SS)
- All Viton elastomers (other materials available for special applications)
- Available with standard NEMA motors
- Built in thrust bearing allows the use of standard off the shelf motors without the need for stack adjustment (3HP and larger)
- Air vent located at the top of casing cover prevents air entrapment causing run dry conditions during start up
- Dimensions and flanges built to industry standards to allow easy retrofit of existing systems
- Optional cartridge size on 32, 45 and 64 series
- Reinforced Impellers and bowls eliminates flexing during operation

## Applications:

- Water Boosting
- Water Supply
- Reverse Osmosis
- Washing Systems
- Boiler Feed
- Fire Misting
- Water Treatment
- Irrigation
- Sprinkler Systems
- Heat Exchangers
- Filtration
- Jockey Pump Service
- Circulation Systems

## Materials:

- 8K – 304SS
- 8KC – 304SS/Cast Iron
- 8KS – 316 SS

## Part Number Breakdown:

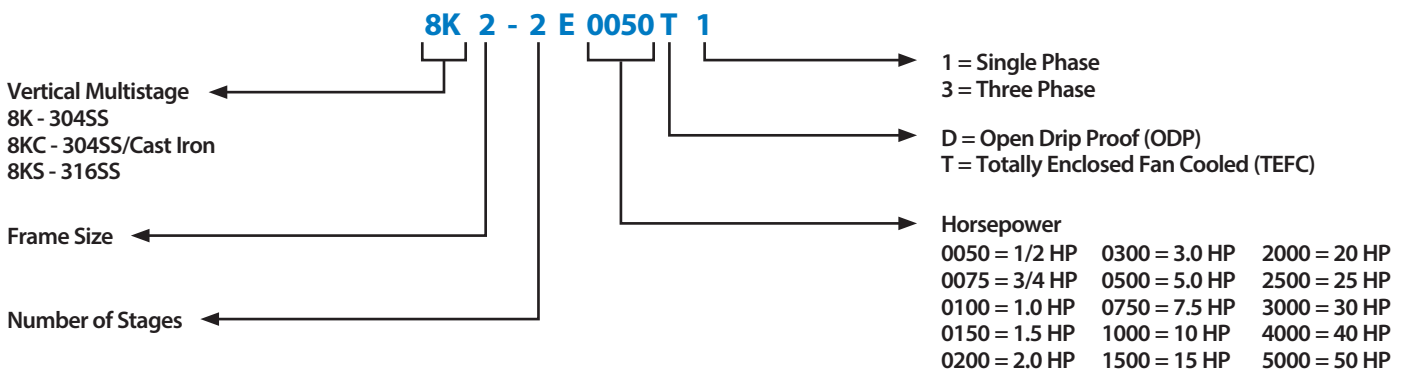

# Model: 8K/8KC/8KS Selection Chart

60 Hz • Synchronous Speed 3450 RPM

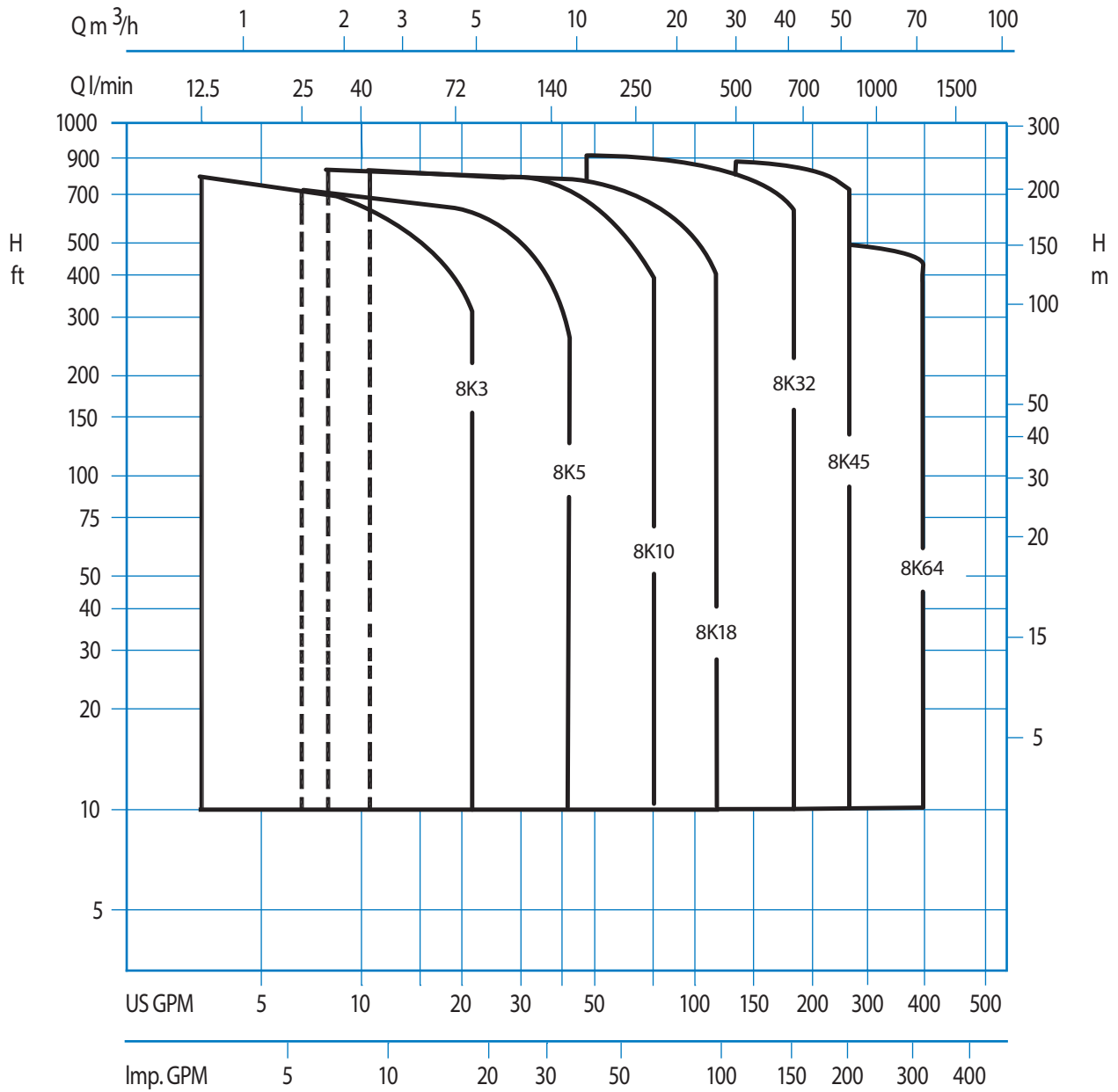

## Individual Model Selection:

8K3 Series .....	Page 4	8K32 Series .....	Page 8
8K5 Series .....	Page 5	8K45 Series .....	Page 9
8K10 Series .....	Page 6	8K64 Series .....	Page 10
8K18 Series .....	Page 7		

# 8K/8KS 3-Series Performance Curves

0.5 HP - 5 HP • Synchronous Speed 3450 RPM • 250# ANSI 1-1/4" 4-Bolt

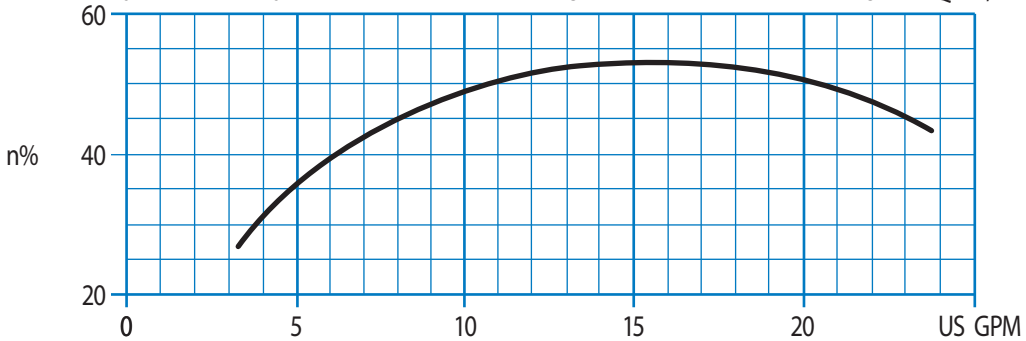
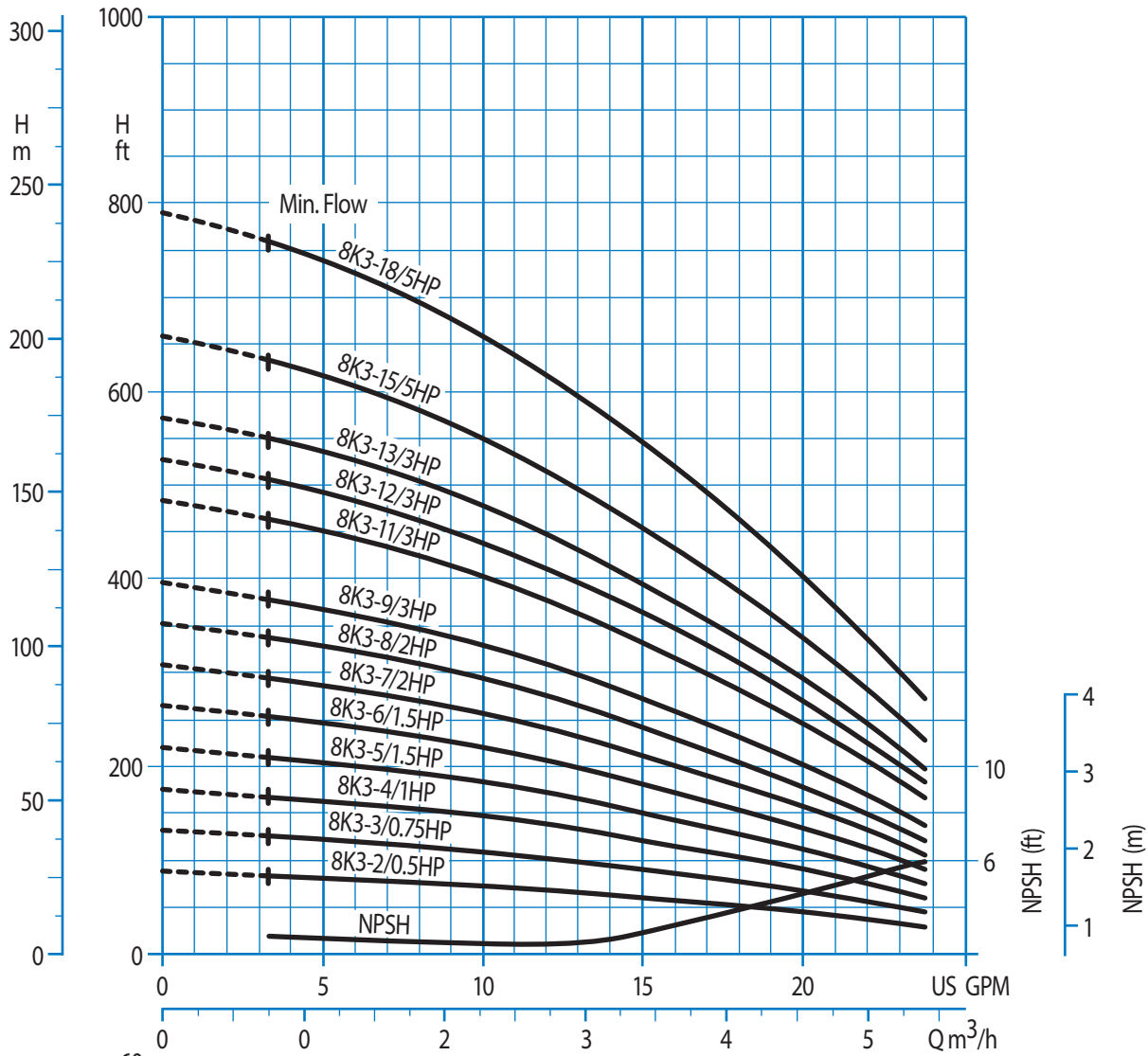

Water Temperature: 68° F (20° C)

# 8K/8KS 5-Series Performance Curves

0.75 HP - 7.5 HP • Synchronous Speed 3450 RPM • 250# ANSI 1-1/4" 4-Bolt

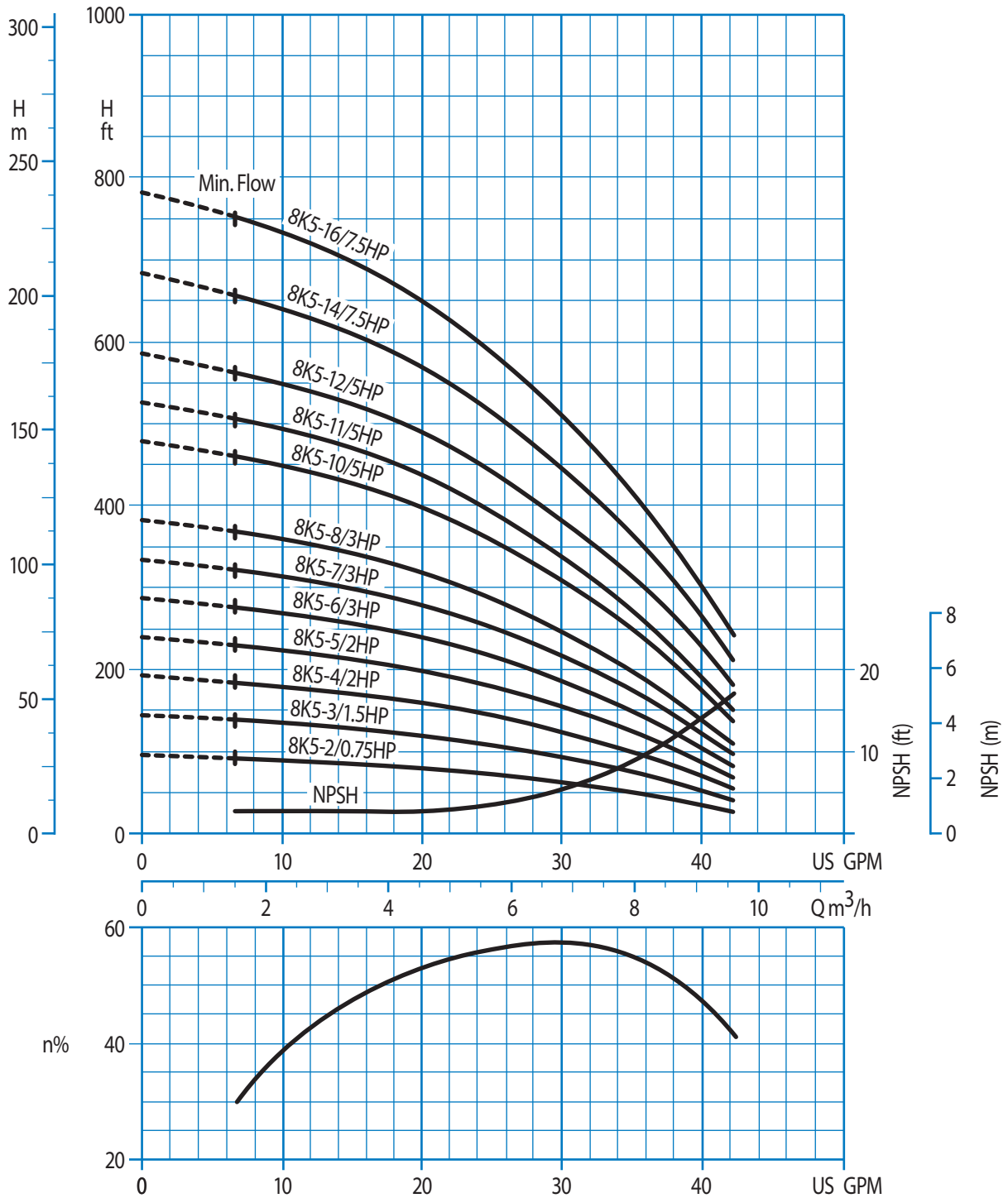

Water Temperature: 68° F (20° C)

# 8K/8KS 10-Series Performance Curves

1.5 HP - 15 HP • Synchronous Speed 3450 RPM • 250# ANSI 2" 8-Bolt

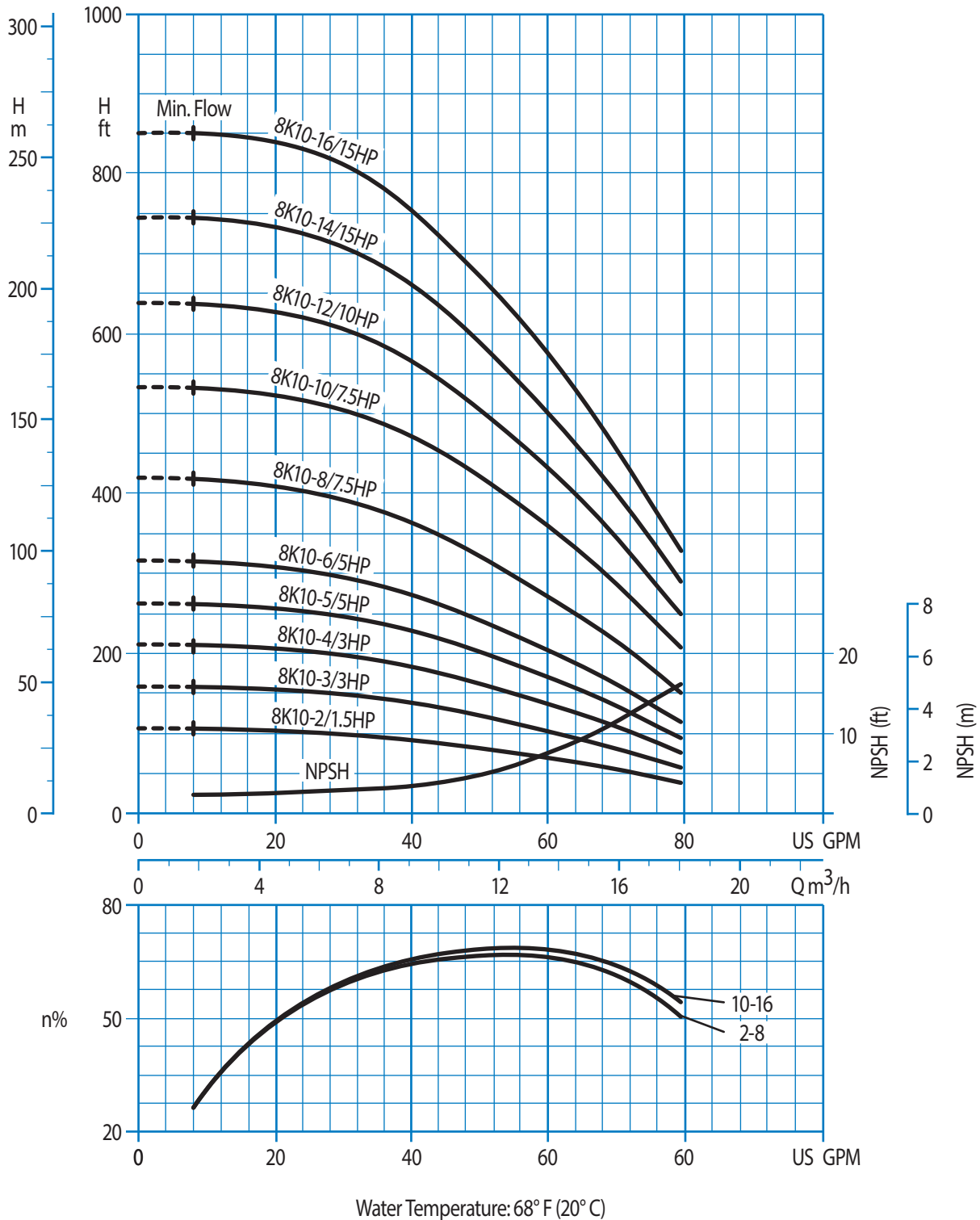

# 8K/8KS 18-Series Performance Curves

5 HP - 25 HP • Synchronous Speed 3450 RPM • 250# ANSI 2" 8-Bolt

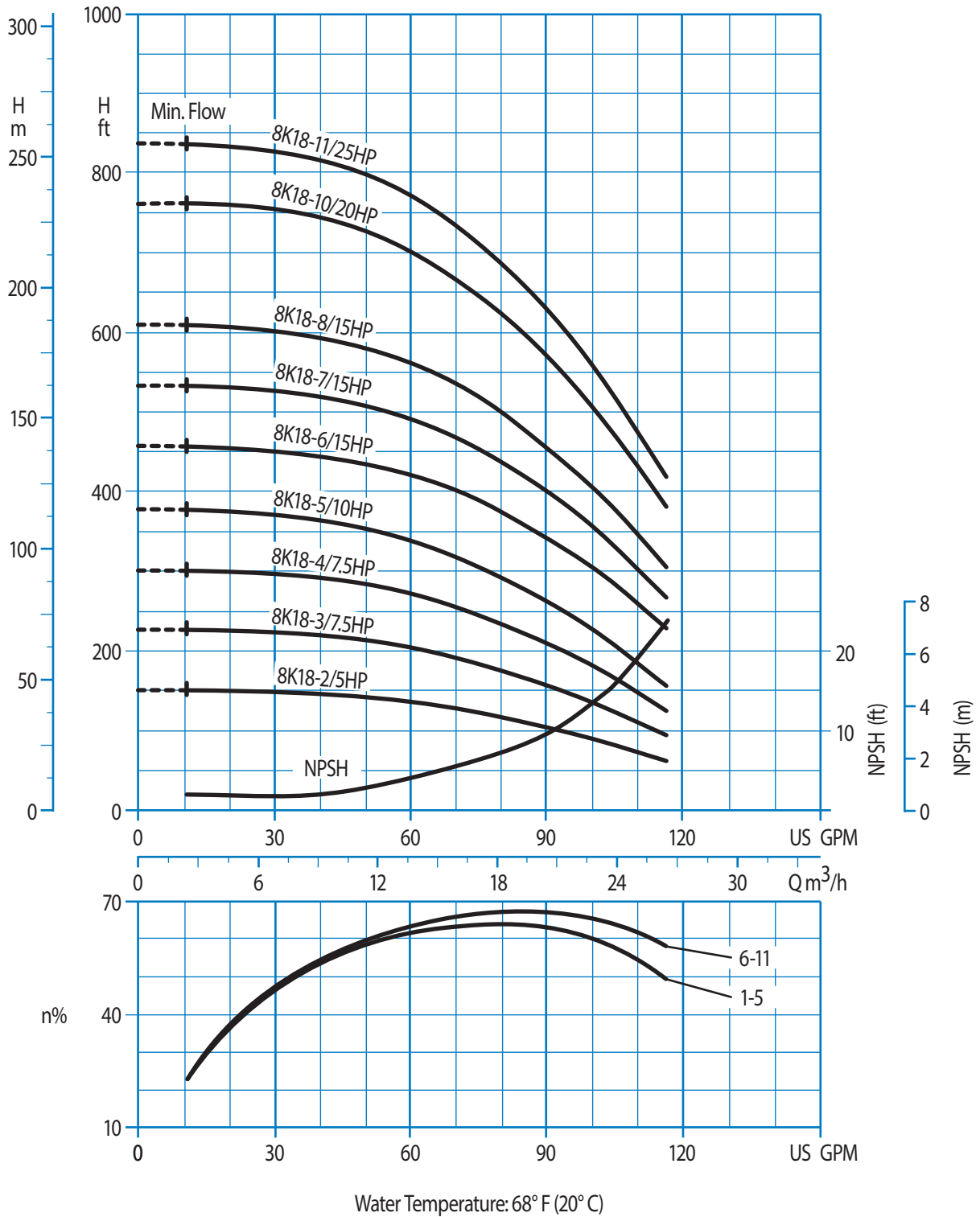

# 8KC/8KS 32-Series Performance Curves

5 HP - 15 HP • Synchronous Speed 3500 RPM • 150# ANSI 2-1/2" 4-Bolt  
 20 HP - 40 HP • Synchronous Speed 3500 RPM • 300# ANSI 2-1/2" 8-Bolt

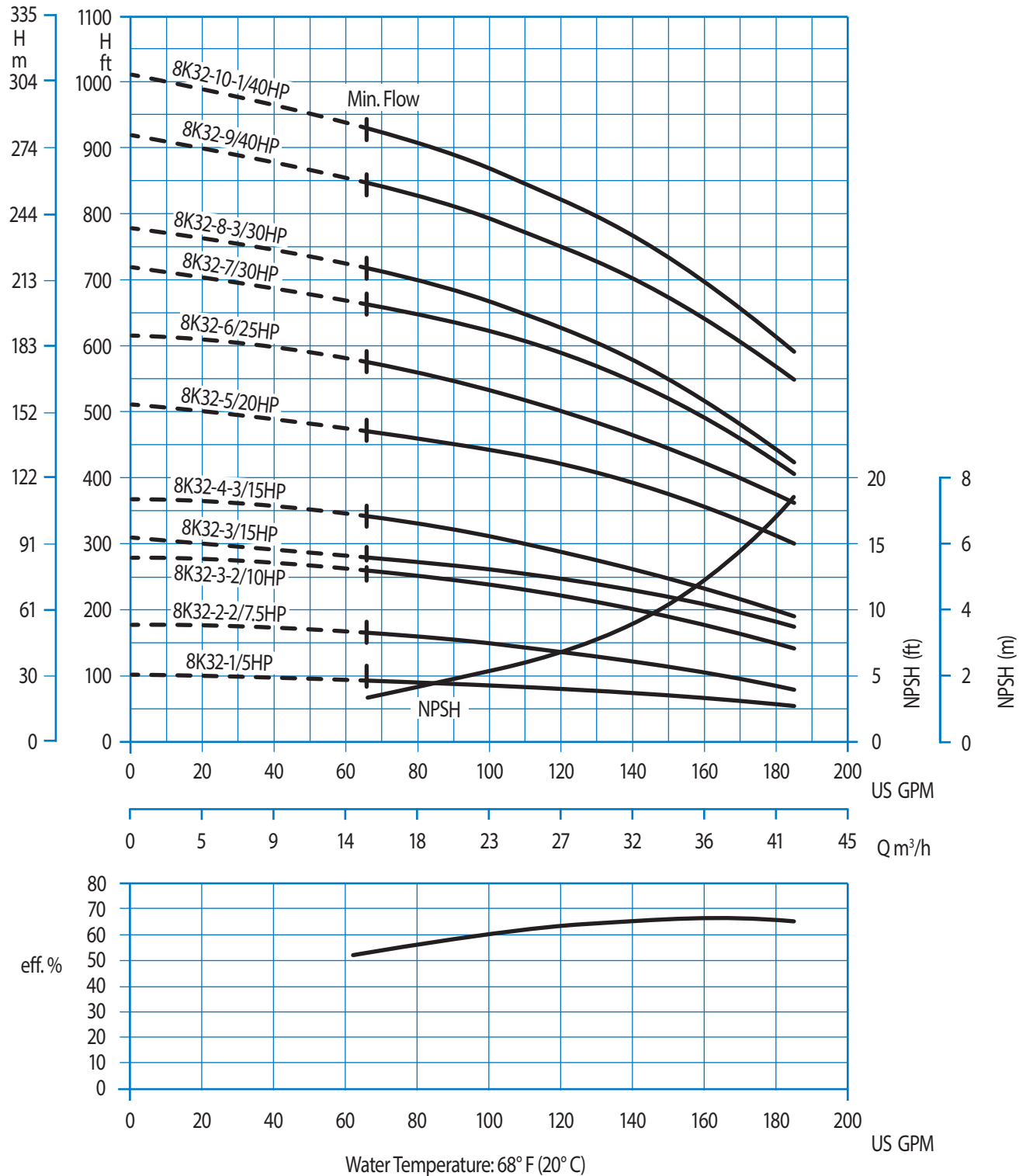



# 8KC/8KS 45-Series Performance Curves

7.5 HP - 25 HP • Synchronous Speed 3500 RPM • 150# ANSI 3" 4-Bolt  
 30 HP - 50 HP • Synchronous Speed 3500 RPM • 300# ANSI 3" 8-Bolt

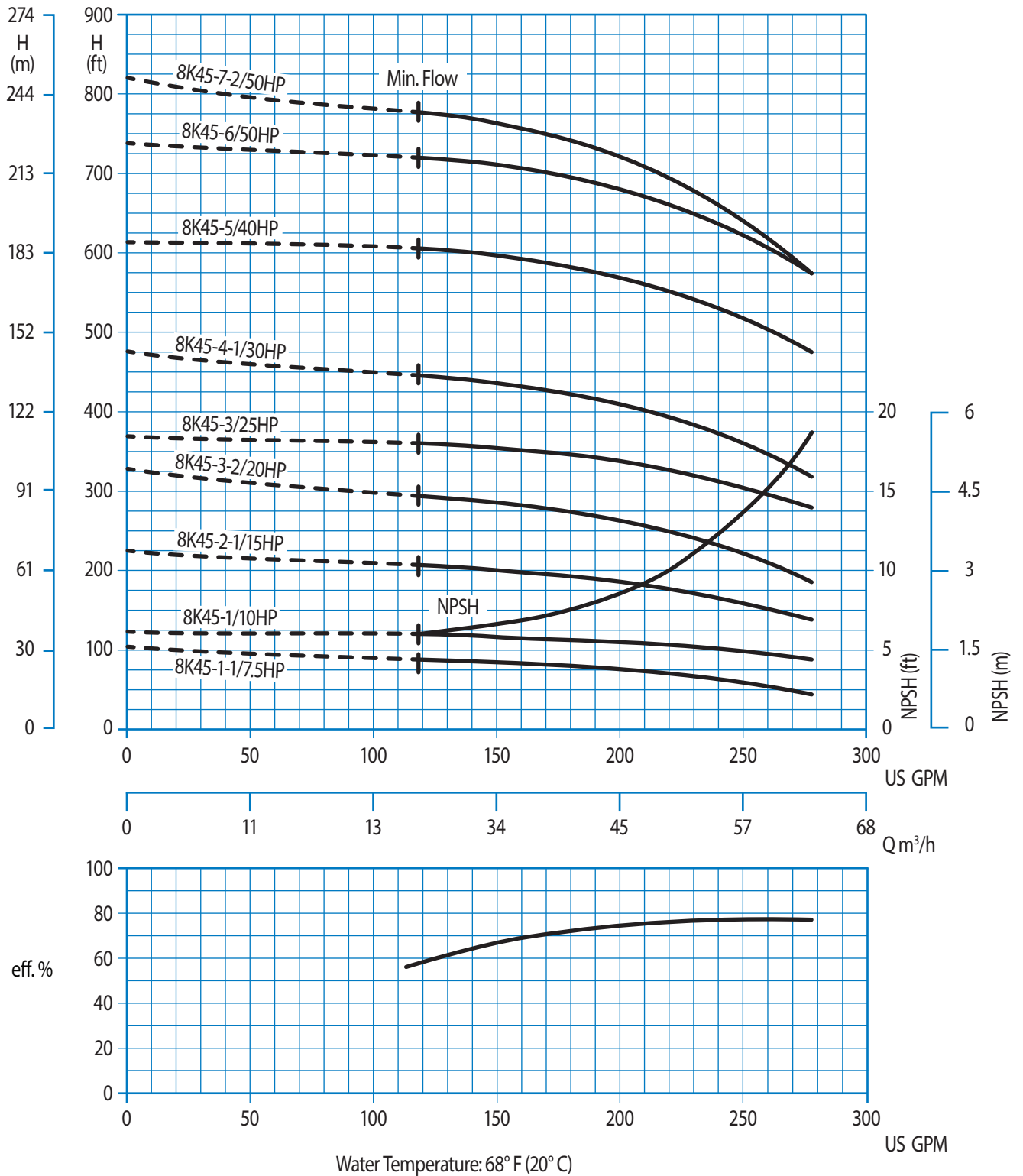

# 8KC/8KS 64-Series Performance Curves

10 HP - 50 HP • Synchronous Speed 3500 RPM • 300# ANSI 4" 8-Bolt

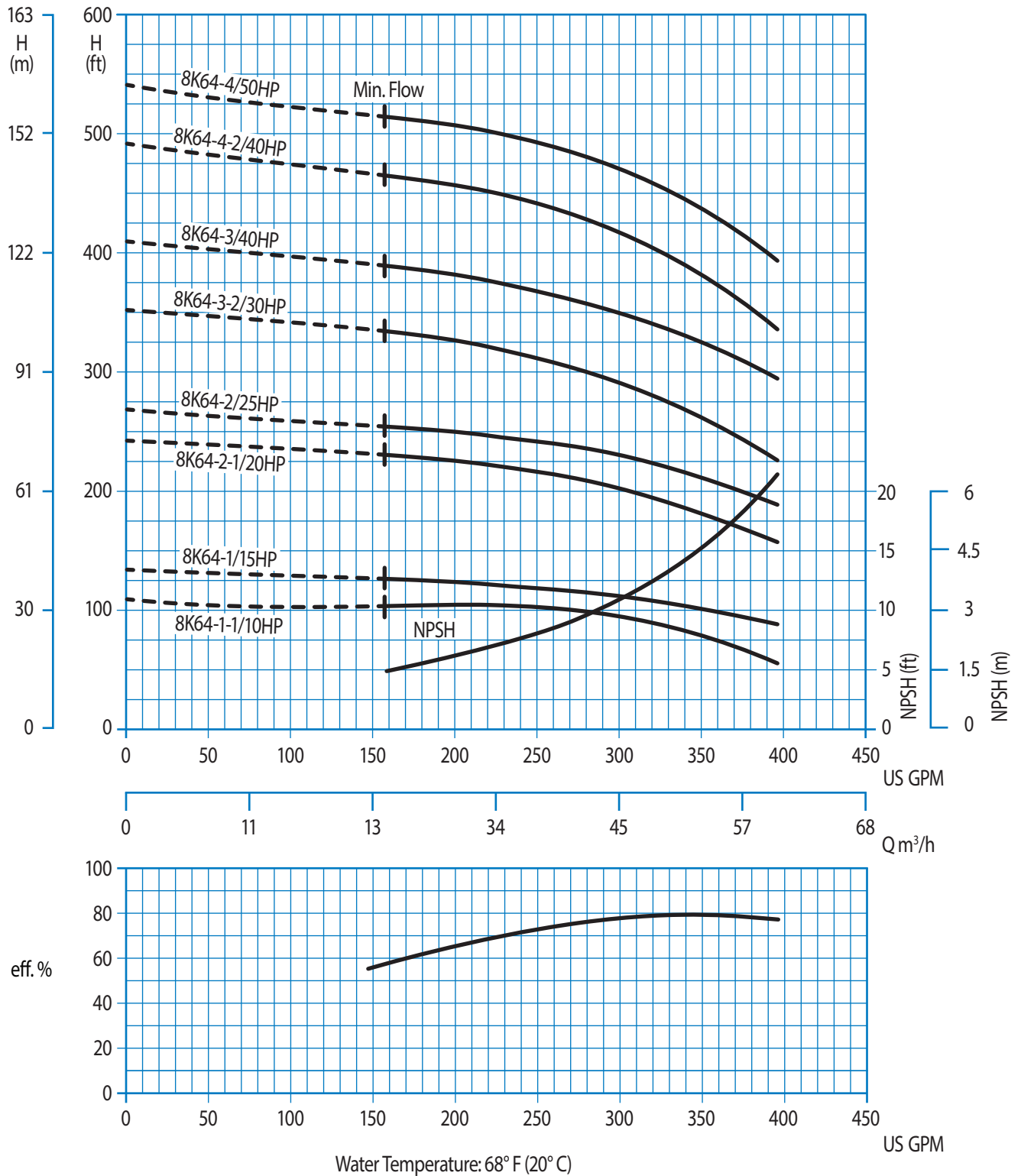

# Additional Centrifugal Pumps

## 304 Stainless Steel Casing

Centrifugal pumps offer solutions for high-flow, low-pressure industrial pumping needs. Typical fluids pumped include fresh water or liquids with some suspended solids. Below is a sampling of popular centrifugal models that include the pump, seal and motor. Most of the pumps listed are rated at 3450 rpm, but many models are available at 1725 rpm.



### SUBMERSIBLE PUMPS WITH INTEGRAL MOTOR AND SEAL\*

45 to 100 gpm (170 to 379 lpm)

PUMP MODEL	MAXIMUM FLOW		MAXIMUM PRESSURE		HORSEPOWER		PHASE/VOLTAGE
	gpm	lpm	psi	bar	hp	kW	
1K100	45	170	10	0.69	0.3	0.2	1PH / 115V**
1K201	73	276	17	1.17	0.5	0.4	1PH / 115V**
1K203	73	276	17	1.17	0.5	0.4	1PH / 115V***
1K205	73	276	17	1.17	0.5	0.4	3PH / 460V***
1K301	74	280	21	1.45	0.8	0.6	1PH / 115V**
1K303	74	280	21	1.45	0.8	0.6	1PH / 115V***
1K305	74	280	21	1.45	0.8	0.6	3PH / 460V***
2K102	88	333	9	0.62	0.5	0.4	1PH / 230V***
2K103	88	333	9	0.62	0.5	0.4	1PH / 230V**
2K200	100	379	11	0.76	1.0	0.7	1PH / 115V**
2K202	100	379	11	0.76	1.0	0.7	1PH / 230V**

\*Motor side seal is NBR fitted Carbon/Ceramic and impeller side seal is Viton® fitted Silicon Carbide/Silicone Carbide.

\*\*Supplied with automatic float switch

\*\*\*Manual models, no float switch

### END-SUCTION MOTORIZED UNITS WITH TEFC 56J NEMA MOTOR

38 to 63 gpm (144 to 238 lpm)

3K132WT0	38	144	62	4.3	2.0	1.5	1PH / 115/208-230V
3K132WT3	38	144	62	4.3	2.0	1.5	3PH / 208-230/460V
3K392BT3	52	197	13	0.9	0.5	0.4	3PH / 208-230/460V
3K142WT0	63	238	32	2.2	1.0	0.7	1PH / 115/208-230V
3K142WT3	63	238	32	2.2	1.0	0.7	3PH / 208-230/460V
3K152WT0	63	238	44	3.0	1.5	1.1	1PH / 115/208-230V
3K152WT3	63	238	44	3.0	1.5	1.1	3PH / 208-230/460V
3K162WT3	63	238	63	4.3	3.0	2.2	3PH / 208-230/460V

Note: All motors are rated at 3450 rpm except model 3K392BT3 which is rated at 1725. All models listed are equipped with a Viton®/Carbon/Ceramic chemical resistant seal. Buna-N and high temperature seals are also available.

### END-SUCTION MOTORIZED UNITS WITH TEFC 213/215JM NEMA MOTOR

153 to 380 gpm (579 to 1,438 lpm)

4K142WT3	153	579	90	6.2	0.5	0.4	3PH / 208-230/460V
4K192WT3	250	946	82	5.7	1.0	0.7	3PH / 208-230/460V
4K252WT3	380	1,438	84	5.8	1.0	0.7	3PH / 208-230/460V

Note: All motors are rated at 3450 rpm. All models listed are equipped with a Viton®/Carbon/Ceramic chemical resistant seal. Buna-N and high temperature seals are also available.

### SELF-PRIMING MOTORIZED UNITS WITH TEFC 56J NEMA MOTOR

18.5 gpm (70 lpm)

5K112WT0	18.5	70	56	3.9	1.0	0.7	1PH / 115/208-230V
5K112WT3	18.5	70	56	3.9	1.0	0.7	3PH / 208-230/460V
5K122WT0	18.5	70	82	5.7	1.0	0.7	1PH / 115/208-230V
5K122WT3	18.5	70	82	5.7	2.0	1.5	3PH / 208-230/460V

Note: All motors are rated at 3450 rpm. All models listed are equipped with a Viton®/Carbon/Ceramic chemical resistant seal. Buna-N and high temperature seals are also available.

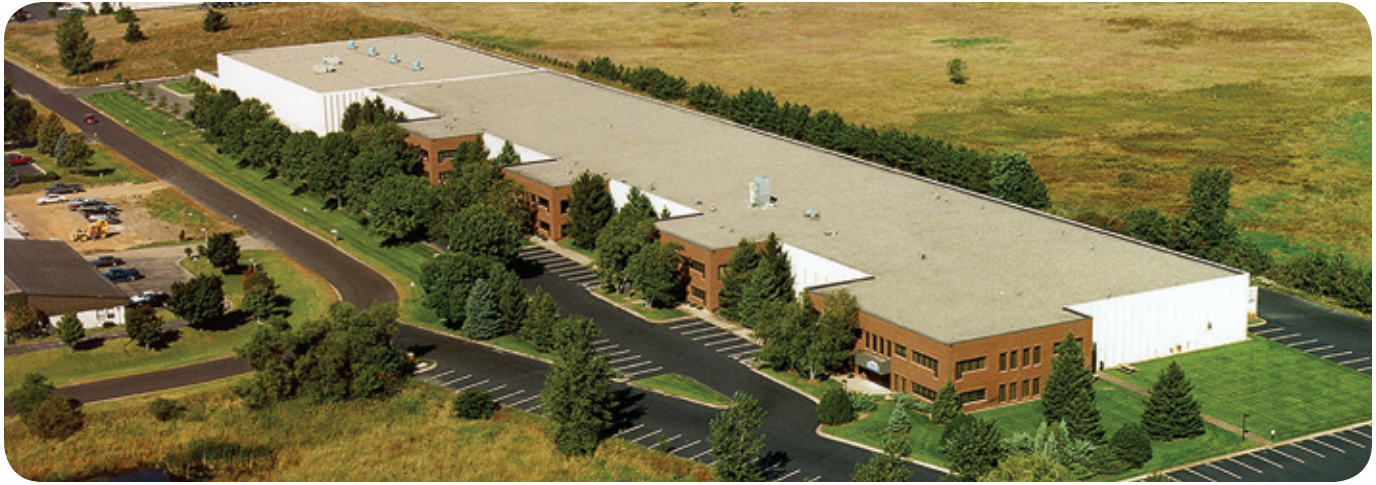

Cat Pumps occupies over 145,000 sq. ft. at its world headquarters in Minneapolis, MN.

## Cat Pumps Locations

### Cat Pumps – World Headquarters

1681 94th Lane Northeast  
Minneapolis, MN 55449  
USA

P: (763) 780-5440  
F: (763) 780-2958  
techsupport@catpumps.com  
www.catpumps.com

#### Territories Served

U.S., Canada

### International Division

P: (763) 780-5440  
F: (763) 785-4329  
intlsales@catpumps.com  
www.catpumps.com

#### Territories Served

Africa, Asia, Australia, Central and South America, Mexico, Middle East, New Zealand, Turkey

### Cat Pumps International N.V.

Heiveldekens 6A  
2550 Kontich  
Belgium

P: 32 3 450 71 50  
F: 32 3 450 71 51  
cpi@catpumps.be  
www.catpumps.be

#### Territories Served

Western Europe (except U.K., Germany, and Austria)

### Cat Pump (U.K.) Ltd.

1 Fleet Business Park, Sandy Lane  
Church Crookham  
FLEET, Hampshire GU52 8BF  
England

P: +44 1252 622031  
F: +44 1252 626655  
sales@catpumps.co.uk  
technical@catpumps.co.uk  
www.catpumps.co.uk

#### Territories Served

England, Ireland, Scotland, N. Ireland, Wales

### Cat Pumps Deutschland GmbH

Buchwiesse 2, D-65510  
Idstein  
Germany

P: +49 6126 9303 0  
F: +49 6126 9303 33  
catpumps@t-online.de  
www.catpumps.de

#### Territories Served

Austria, Commonwealth of Independent States (CIS), Germany and Eastern Europe

**SALES, DISTRIBUTION, SERVICE** Call today for product and application assistance. (763) 780-5440 or visit us at [www.catpumps.com](http://www.catpumps.com)



### CAT PUMPS

1681 - 94TH LANE N.E. MINNEAPOLIS, MN 55449-4324  
PHONE (763) 780-5440 — FAX (763) 780-2958  
e-mail: techsupport@catpumps.com  
www.catpumps.com

For International inquiries go to [www.catpumps.com](http://www.catpumps.com) and navigate to the "Contact Us" link.

©2014 Cat Pumps Inc. All rights reserved. All written and visual data contained in this document are based on the latest product information available at the time of publication. Cat Pumps reserves the right to make changes at any time without notice. All other brand names or marks are used for identification purposes and are trademarks of their respective owners.