

DATA SHEET

5 FRAME PLUNGER PUMPS



Stainless Steel Models

311, 341, 351

Stainless Steel Flushed Models

311C, 341C, 351C

Nickel Aluminum Bronze Models

317, 347, 357

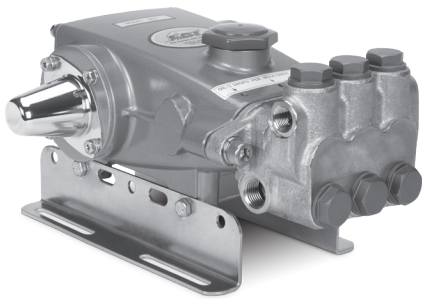

Model 311 Shown
(Shaft protector and mounting rails sold separately)

FEATURES

- Triplex plunger design ensures high efficiency and low pulsation.
- Durable high-pressure seals are lubricated and cooled by pumped liquid.
- Pre-set low-pressure seals provide secondary protection against external leaks and require no packing adjustment.
- Models 311C, 341C and 351C offer an external flush for high-temperature liquids or low-lubricity liquids.
- Pump comes standard with NBR seals. Alternative seal materials are available for higher temperature or chemical compatibility.

COMMON

SPECIFICATIONS	U.S.	Metric
Max. Liquid Temperature (NBR)	160° F	71° C
Alternative seals available for higher temperatures up to 200° F		
Bore	0.787"	20 mm
Crankcase Capacity	18 oz	0.53 l
Inlet Ports (2)	½" NPT(F)	½" NPT(F)
Flush Ports (2) (311C, 341C, 351C)	⅛" NPT(F)	⅛" NPT(F)
Discharge Ports (2)	⅜" NPT(F)	⅜" NPT(F)
Shaft Diameter	0.787"	20 mm
Weight	19.8 lbs	9 kg
Dimensions	11.81 x 10.00 x 5.24"	300 x 254 x 133 mm

SPECIFICATIONS	U.S. Measure	Metric Measure
311, 311C, 317		
Flow	4.0 gpm	15 lpm
Pressure Range	100–2200 psi	6.9–152 bar
Pump RPM*	950 rpm	950 rpm
Inlet Pressure Range	-5–60 psi	-0.35–4.1 bar
Stroke	0.709"	18 mm
ALTERNATIVE SPECIFICATIONS 311, 311C		
Flow	5.0 gpm	19 lpm
Pressure Range	100–1500 psi	6.9–103 bar
Pump RPM*	1190 rpm	1190 rpm
ALTERNATIVE SPECIFICATIONS 317		
Flow	5.0 gpm	19 lpm
Pressure Range	100–2000 psi	6.9–138 bar
Pump RPM*	1190 rpm	1190 rpm
341, 341C, 347 Direct Drive		
Flow	4.0 gpm	15 lpm
Pressure Range	100–1800 psi	6.9–124 bar
Pump RPM*	1725 rpm	1725 rpm
Inlet Pressure Range	Flooded to 60 psi	Flooded to 4.1 bar
Stroke	0.394"	10 mm
351, 351C, 357 Direct Drive		
Flow	5.0 gpm	19 lpm
Pressure Range	100–1500 psi	6.9–103 bar
Pump RPM*	1725 rpm	1725 rpm
Inlet Pressure Range	Flooded to 60 psi	Flooded to 4.1 bar
Stroke	0.472"	12 mm

*Pump minimum is 100 RPM

ALTERNATIVE SEAL CONFIGURATION

MATERIAL	SUFFIX CODE	MAXIMUM TEMPERATURE
NBR	—	160° F (71° C)
FPM	.0110	180° F (82° C)
EPDM	.0220	160° F (71° C)
FFKM	.0770	200° F (93° C)
HT	.3000	180° F (82° C)
STHT	.3400	190° F (88° C)

See **Tech Bulletin 002** for inlet conditions and RPM at high temperature.

$$\text{DETERMINING THE PUMP RPM} \quad \frac{\text{Rated gpm}}{\text{Rated rpm}} = \frac{\text{Desired gpm}}{\text{Desired rpm}}$$

$$\text{DETERMINING THE REQUIRED HP} \quad \frac{\text{Hp (Electric Brake)}}{1460} = \frac{\text{gpm} \times \text{psi}}{1460}$$

$$\text{DETERMINING MOTOR PULLEY SIZE} \quad \frac{\text{Motor Pulley OD}}{\text{Pump rpm}} = \frac{\text{Pump Pulley OD}}{\text{Motor rpm}}$$

Refer to pump **Service Manual** for repair procedure and additional technical information.

PARTS LIST

ITEM	PART NUMBER	MATL	PART NUMBER	MATL	DESCRIPTION	QTY
	311, 311C, 341, 341C, 351, 351C		317, 347, 357			
5	92538	S	92538	S	Screw, Sems HHC (M6x16) (See Tech Bulletin 074)	8
8	43344	AL	43344	AL	Cover, Bearing	1/2
10	43343	NBR	43343	NBR	O-Ring, Bearing Cover-70D	2
11	43222	NBR	43222	NBR	Seal, Oil, Crankshaft (Models 311, 311C, 317, 341, 341C, 347 351, 351C, 357)	2/1
15	14480	STL	14480	STL	Bearing, Ball	2
20	45883	HS	45883	HS	Rod, Connecting Assembly (See Tech Bulletin 074)	3
25	43342	FCM	43342	FCM	Crankshaft, Dual End (M18) (Models 311, 311C, 317)	1
	44945	FCM	44945	FCM	Crankshaft, Single End (M10) (Models 341, 341C, 347)	1
	43838	FCM	43838	FCM	Crankshaft, Dual End (M12) (Models 351C, 357)	1
30	44949	AL	44949	AL	Cover, Blind Shaft (Models 341, 341C)	1
32	43211	ABS	43211	ABS	Cap, Oil Filler	1
33	14177	NBR	14177	NBR	O-Ring, Filler Cap-70D	1
37	92241	PC	92241	PC	Gauge, Oil, Bubble with Gasket (See Tech Bulletin 074)	1
38	44428	NBR	44428	NBR	Gasket, Flat, Oil Gauge-80D	1
40	92542	S	92542	S	Screw, Sems HHC (M6 x 20) (See Tech Bulletin 074)	4
48	25625	STCP	25625	STCP	Plug, Drain (1/4" x 19 BSP)	1
49	23170	NBR	23170	NBR	O-Ring, Drain Plug-70D	1
50	48772	AL	48772	AL	Cover, Rear	1
51	48773	NBR	48773	NBR	O-Ring, Rear Cover	1
53	48769	AL	48769	AL	Crankcase	1
56	43355	POP	43355	POP	Pan, Oil	1
64	43351	CM	43351	CM	Pin, Crosshead	3
65	45256	SSZZ	45256	SSZZ	Rod, Plunger	3
70	43228	NBR	43228	NBR	Seal, Oil, Crankcase	3
75	43328	S	43328	S	Slinger, Barrier	3
88	45697	S	45697	S	Washer, Keyhole (M18 x 10)	3
90	43367	CC	43367	CC	Plunger (M20 x 72)	3
95	89653	SS	89653	SS	Stud, Plunger Retainer (M6 x 58)	3
96	43235	PTFE	43235	PTFE	Backup Ring, Plunger Retainer	3
97	17399	NBR	17399	NBR	O-Ring, Plunger Retainer-80D	3
98	44041	SS	44041	SS	Gasket	3
99	44031	SS	44031	SS	Retainer, Plunger (See Tech Bulletin 074)	3
100	45688	PVDF	45688	PVDF	Retainer, Seal 2-Piece	3
101	43302	—	43302	—	Wick, Long Tab	3
106	44127	NBR	44127	NBR	Seal, Low-Pressure with SS-Spring	3
120	45680	SS	45680	SS	Case, Seal	3
121	14200	NBR	14200	NBR	O-Ring, Seal Case-70D	3
125	44649	SNG	44649	SNG	Seal, High-Pressure with SS-Support	3
139	45156	SS	44563	NAB	Plug, Inlet (1/2" NPT[M])	1
162	48361	D	48361	D	Backup Ring, Seat	6
163	43358	NBR	43358	NBR	O-Ring, Seat-70D	6
164	44128	SS	44128	SS	Seat	6
166	44057	SS	44057	SS	Valve	6
167	44056	SS	44056	SS	Spring, Valve	6
168	44565	PVDF	44565	PVDF	Retainer, Valve Spring	6
171	44832	S	44832	S	Spring, Coil	6
172	17615	NBR	17615	NBR	O-Ring, Valve Plug-75D	6
174	49296	SS	44833	NAB	Plug, Valve (See Tech Bulletin 074)	6
185	45151	SS	44124	NAB	Manifold Head	1
	49583	SS	—	—	Manifold Head-Flushed (Models 311C, 341C, 351C)	1
186	15847	S	15847	S	Lockwasher (M10)	2
188	87950	S	87950	S	Screw HSH (M10 x 35) (See Tech Bulletin 074)	2

Bold print part numbers are unique to a particular pump model.

*Italics are optional items. *Review individual parts in each kit for material code information.*

For additional technical information see www.catpumps.com/literature/tech-bulletins MATERIAL CODES (Not Part of Part Number): ABS=ABS Plastic AL=Aluminum
 CC=Ceramic CM=Chrome-moly D=Acetal EPDM=Ethylene Propylene Diene Monomer FCM=Forged Chrome-moly FFKM=Perfluoroelastomer FPM=Fluorocarbon
 HS=High Strength HT=High Temp (EPDM Alternative) NAB=Nickel Aluminum Bronze NBR=Medium Nitrile (Buna-N) PC=Poly Carbonate POP=Polypropylene
 PTFE=Pure Polytetrafluoroethylene PVDF=Polyvinylidene Fluoride S=304SS SFTA=Special Blend PTFE Tan SNG=Special Blend (Buna) SS=316SS
 SSZZ=316SS/Zamak STL=Steel STCP=Steel/Chrome Plated STZP=Steel/Zinc Plated

Optional Parts and Accessories and Service Parts listed on page 3. Standard and optional Seal and Valve Kits listed on page 4.

EXPLODED VIEW

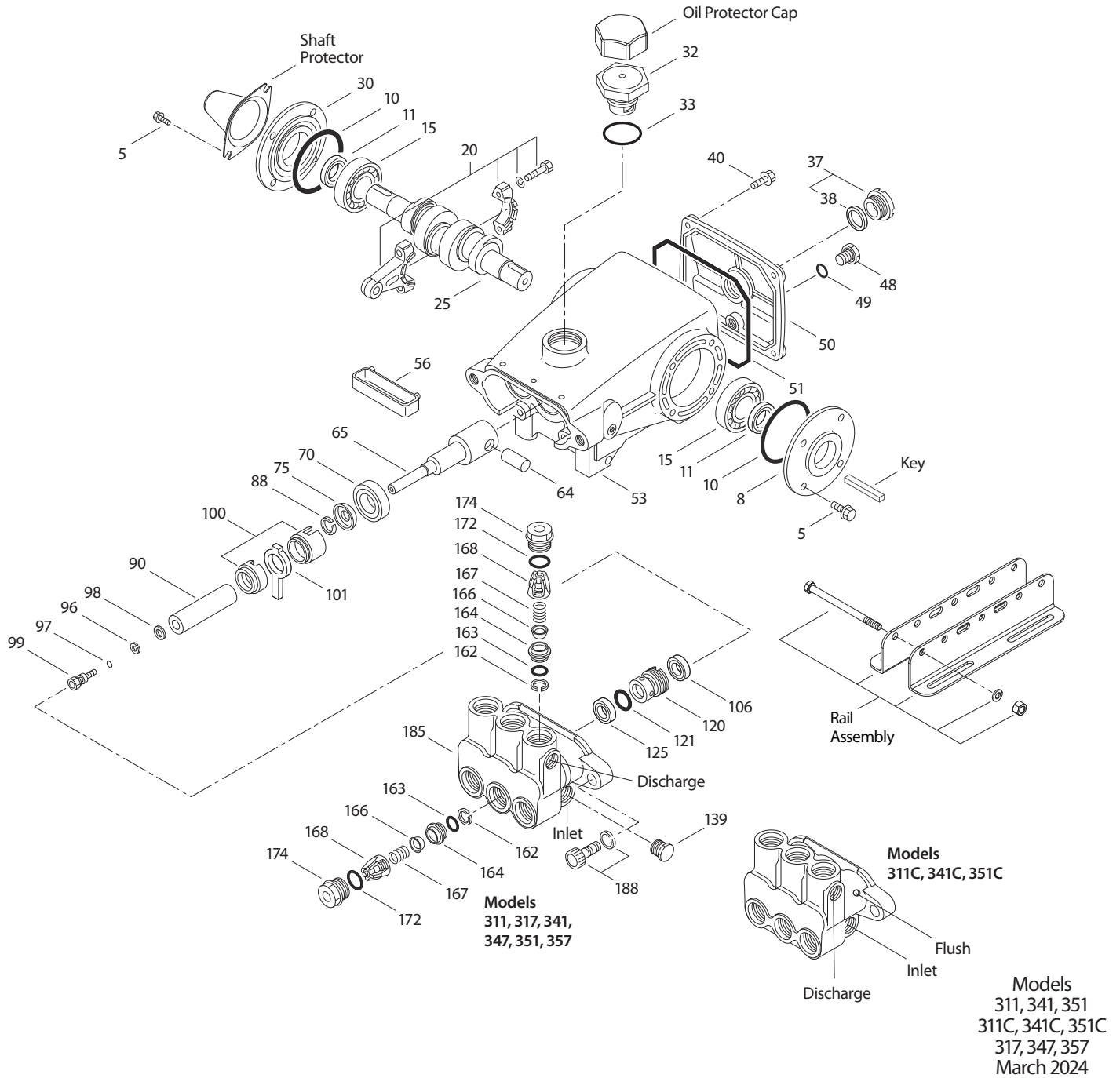

OPTIONAL PARTS AND ACCESSORIES

PART	DESCRIPTION	QTY
30057	Key (M6 x 6 x 25)	1
30659	Kit, Complete Mounting	1
30611	Mount, Rail Assembly (Belt Drive Only)	1
30243	Mount, Direct (Belt Drive Only)	1
118672	Protector, Shaft	1
828710	Protector, Oil Cap	1
30633	Assembly, Pulley & Key (Not Shown)	1
30944	Assembly, Hub & Key (Not Shown)	1
34334	Kit, Oil Drain (3/8" x 24") (Not Shown)	1

SERVICE PARTS

PART	DESCRIPTION	QTY
34153	Kit, Seal – Standard NBR	1
31152	Kit, Valve – Standard NBR	2
6107	Oil, Bottle (21 oz) (Fill to Specified Crankcase Capacity Prior to Start-up)	1
6139	Lubricant, Anti-Seize (8 oz) (See Tech Bulletin 095)	1
30696	Reverse Pliers (Not Shown)	1
33004	Socket, Seal Case (1/2" Drive) (Not Shown)	1
812207	Head, Complete with NBR Seals and O-Rings (Models 311, 341, 351)	1
818444	Head, Complete with NBR Seals and O-Rings (Models 311C, 341C, 351C)	1
814559	Head, Complete with NBR Seals and O-Rings (Models 317, 347, 357)	1

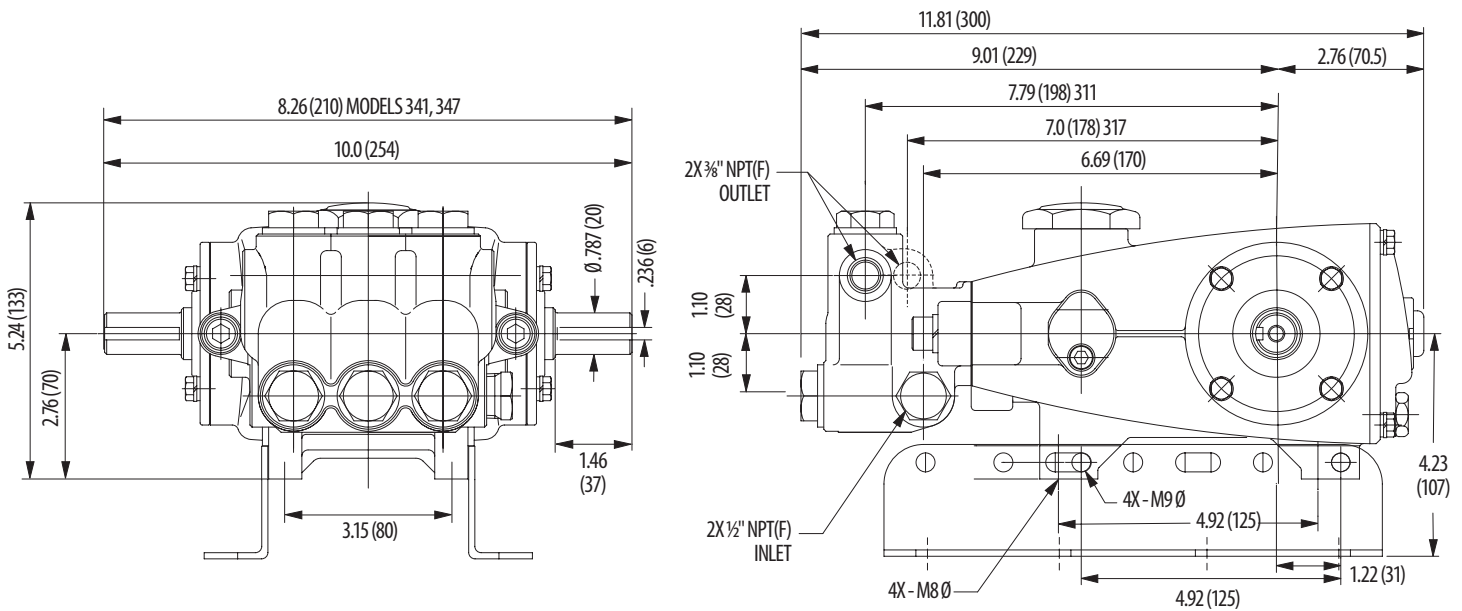

Models 311, 317, 351, 357

SEAL KITS One (1) seal kit required per pump

PUMP MODELS	NBR (STD)	FPM (.0110)	EPDM (.0220) ◆	FFKM (.0770)	HT (.3000)	STHT (.3400)
311, 341, 351 311C, 341C, 351C 317, 347, 357	34153	34155	31163*	76623*	33623	77031

ITEM (Included in Seal Kits)							DESCRIPTION	QTY
97	17399	14160	46204	701715	17399	17399	O-Ring, Plunger Retainer	3
101	43302	43302	43302	43302	43302	43302	Wick, Long Tab	3
106	—	—	—	—	—	76305	Seal, Low-Pressure with S-Spring	3
	44127	45153	48429	—	43305	—	Seal, Low-Pressure with SS-Spring	3
	—	—	—	701763	—	—	Seal, Low-Pressure with NIH - Spring	3
121	14200	11719	48907	701716	14200	14200	O-Ring, Seal Case	3
125	44649	—	—	—	—	—	Seal, High-Pressure with S-Support	3
	—	44936	—	—	—	—	Seal, High-Pressure with SS-Support	3
	—	—	46667	—	46667	46667	Seal, High-Pressure with 2-Piece Support	3
125	—	—	—	701764	—	—	Seal, High-Pressure with NIH - Spring	3

◆ Silicone oil/grease required *Review material code for individual items (HT may be used as an alternative)

VALVE KITS Two (2) valve kits required per pump

PUMP MODELS	NBR (STD)	FPM (.0110)	EPDM (.0220)	FFKM (.0770)	HT (.3000)	STHT (.3400)
311, 341, 351 311C, 341C, 351C 317, 347, 357	31152	34152	76148	76821	31152	31152

ITEM (Included in Valve Kits)							DESCRIPTION	QTY
162	48361	48361	48361	48361	48361	48361	Backup Ring, Seat	3
163	43358	44938	48908	701717	43358	43358	O-Ring, Seat	3
164	44128	44128	44128	44128	44128	44128	Seat	3
166	44057	44057	44057	44057	44057	44057	Valve	3
167	44056	44056	44056	44056	44056	44056	Spring	3
168	44565	44565	44565	44565	44565	44565	Retainer, Spring	3
171	44832	44832	44832	44832	44832	44832	Spring, Coil	3
172	17615	15855	48431	701718	17615	17615	O-Ring, Valve Plug	3

◆ Silicone oil/grease required

⚠ CAUTIONS AND WARNINGS

All high-pressure systems require a primary pressure regulating device (e.g. regulator, unloader) and a secondary pressure relief device (e.g. pop-off valve, relief valve). Failure to install such relief devices could result in personal injury or damage to pump or property. Cat Pumps does not assume any liability or responsibility for the operation of a customer's high-pressure system. Read all CAUTIONS and WARNINGS before commencing service or operation of any high-pressure system. The CAUTIONS and WARNINGS are included in each Service Manual and with each Accessory Data sheet. CAUTIONS and WARNINGS can also be viewed online at www.catpumps.com/dynamic-literature/cautions-and-warnings or can be requested directly from Cat Pumps.

WARRANTY

View the Limited Warranty online at www.catpumps.com/literature/cat-pumps-limited-warranty